

Wilkhahn

Palette. 640 range.





Palette.

Solid. Understated.
Ingeniously versatile.

Built to last: a solid-wood table top, resting on four column-shaped, table legs that are flush with the edge of the table top. Unlike virtually any other table range, Palette stands for the contemporary archetypal table. In terms of function and aesthetic appeal, the black top of the table legs and the glide are perfection itself. But Palette can do more: in just one simple step the leg can be released and moved to accommodate another panel. As a result, you can create, extend or divide tables to suit the way you want to use the room, procedures and numbers concerned – from a table for one or two, to a conference layout.

The rigid blockboard tops do not require any underframes. This creates more legroom and allows space-saving stacking (like pallets) of any table tops not currently needed. And what's more, in addition to standard table tops, the ingenious design allows customised ones and the integration of state-of-the-art media equipment too.



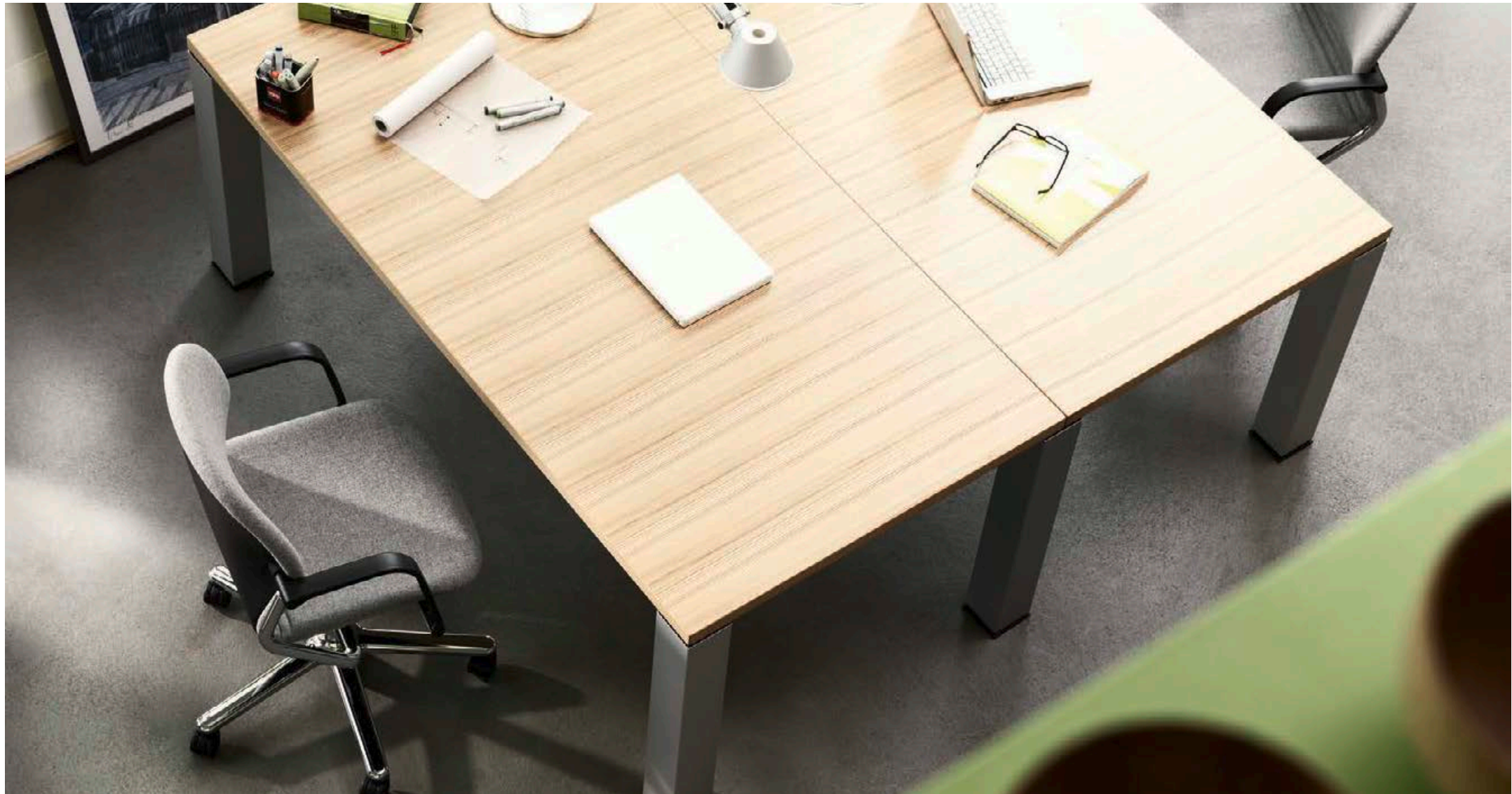

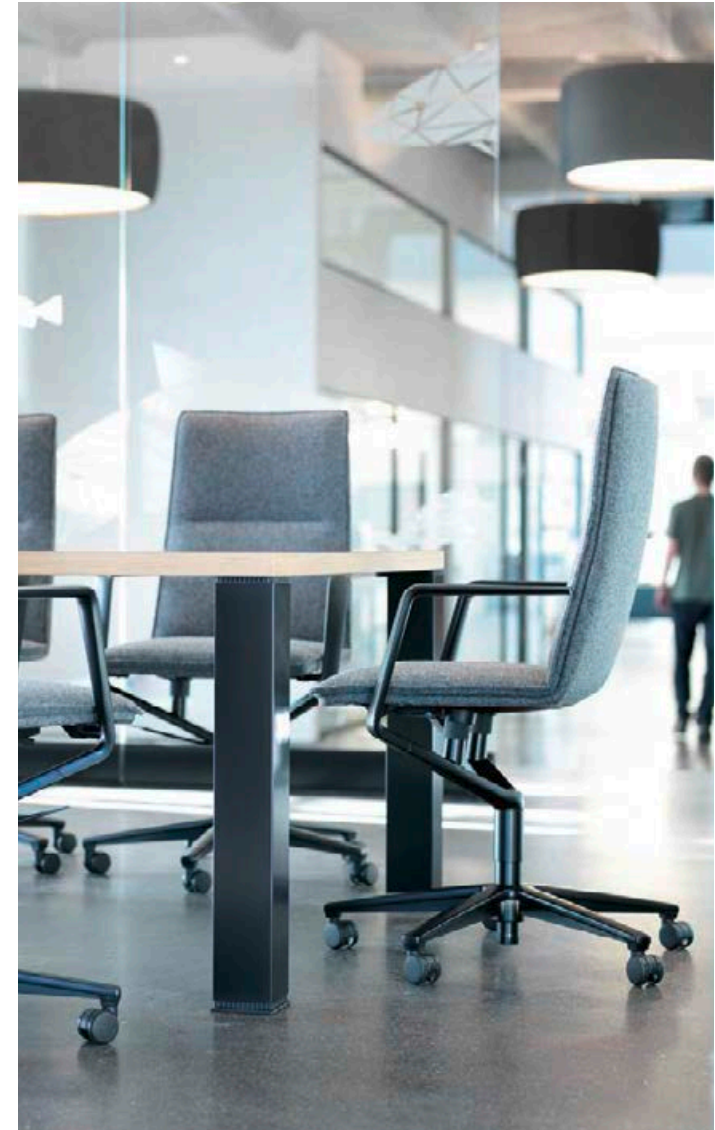

Palette. 640 range. Technical details.

Wilkhahn

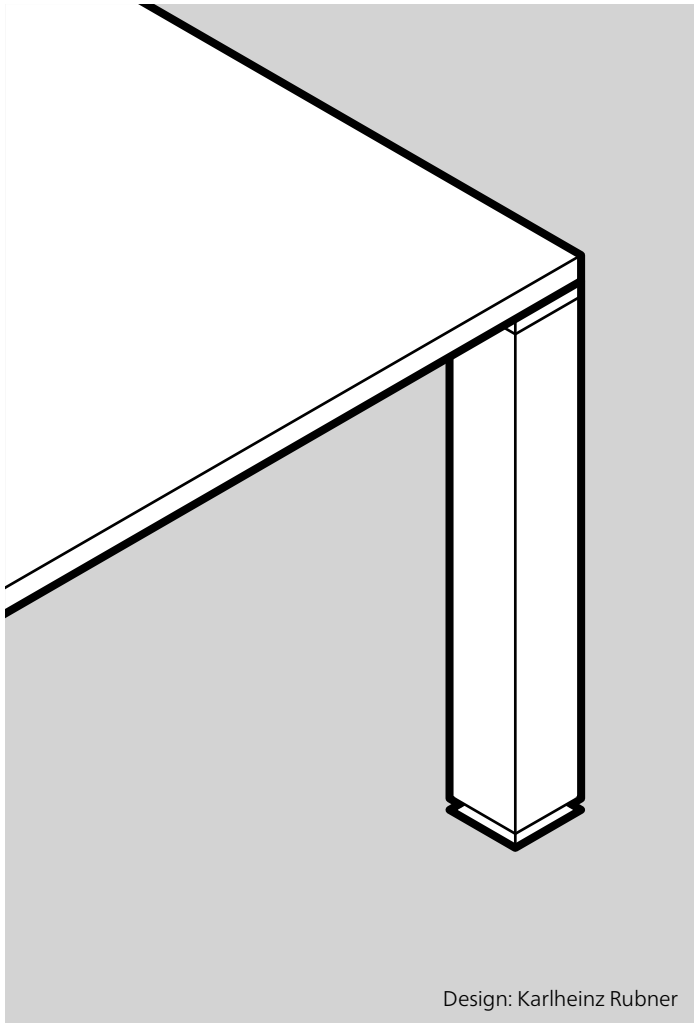

Design: Karlheinz Rubner

Function

Flexible prestigious table system with options ranging from the standalone table to sophisticated conference table systems for office, seminar and conference spaces. Table top formats and edges as well as table leg types can be optionally adapted to integrate with different design concepts. Ideal for customised conference table systems and integrating state-of-the-art multimedia equipment.

Standardised system panels for table configurations:

All standardised system panels can be connected with one another. Panels for specific table systems can only be combined with each other, i.e. not with standardised system panels.

Frame

Legs in square aluminium profile 100 x 100 mm, clear anodised or coated, with four pins each and connected with a bayonet lock integrated into the table top. Optionally with legs in round Ø 65 mm aluminium tubing (also possible here with a bright chrome-plated finish). Base elements with black polyamide glides.

Core material of table top

Laminboard with straight, concealed lipping. On request, lipping also with bullnose profile (sides of tables that are to be linked are only available with a straight edge). Integrated connecting mechanism for attaching the legs.

Table top group 1 – laminate

Thickness 39 mm Laminate based on Wilkhahn colour and surface finish samples with laminated beech lipping, natural oiled finish

Table top group 2 – veneer

Thickness 39 mm Variant 1: Beech veneer based on the Wilkhahn woodstain colour samples with laminated beech lipping, colour matched as far as possible with the veneer, or oak or ash veneer based on the Wilkhahn woodstain colour samples with lipping, colour matched as far as possible with the veneer. Variant 2: Maple, walnut or elm veneer, as well as Wilkhahn Mocca veneer from the Wilkhahn woodstain colour samples with wood lipping colour matched as far as possible with the veneer.

Veneer types

As a standard, the veneer panels are slip-matched. Surfaces sealed with clear lacquer: open-pore: oak, ash, walnut and elm veneer, as well as Wilkhahn Mocca veneer closed-pore: maple and beech veneer. Bottom of table in beech veneer, mostly colour matched with the veneer on the table top. Ein durchgängiger furnierverlauf. Some specific growth features possible.

Table top group 3 – linoleum

Thickness 40 mm Linoleum from the Wilkhahn woodstain colour samples, with laminated beech lipping, natural oiled finish.

Standards

The Palette tables comply with the ANSI/BIFMA X 5.5 standard.

When placing repeat orders, please indicate whether your table tops have slip-matched or book-matched veneer.

We guarantee that the pattern of the veneer will be continuous on the joining edges up to 270 cm max.

Edge profiles



Straight edge

Palette. 640 range. Product types.

Wilkhahn

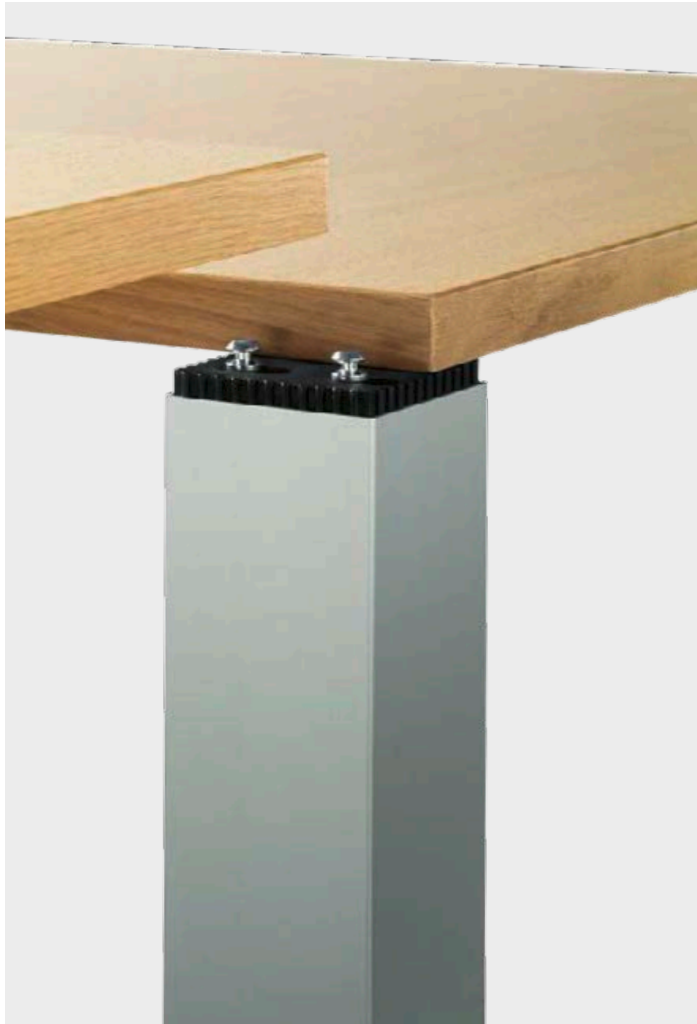

Veneered table tops, laminate (not pictured) and linoleum (not pictured) each available as specified on Wilkhahn's material sample card. Bright chrome-plated aluminium table frames (not pictured), coated in a silver satin finish or black and clear anodised (not pictured).

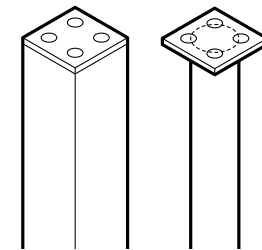

Leg shapes for systems tables and table layouts: square and round. Different table edges, veneers, linoleum and laminates leave plenty of room for the imagination.

Palette. 640 range. Product types.

Wilkhahn

Table top groups



Laminate, veneer type 1 or 2, linoleum, you can find further surfaces in our media center.

Laminate. The material is made by bonding cellulose and décor paper layers, as well as resin, by applying heat and pressure. This produces an extremely tough surface that comes in a variety of different colours. Laminate is highly recommended for areas where the tables are subject to a lot of wear and tear because they are frequently moved around for example.

Wood veneers. Natural wood is a living material: in the way it looks and changes over the years. Sometimes more significantly and sometimes more subtly, depending on the type of wood and how light it is. If a more consistent look is preferred, stained surfaces or industrially produced veneer (e.g. mocha) are available.

Linoleum. The material consists of linseed oil and natural resin that is applied to a backing layer and protected with a matt-glossy lacquer. In terms of haptics, it is not just extremely pleasant, but is naturally anti-static too. Virtually no finger prints or dust stick to the surface. Over the years linoleum table tops gain a characteristic patina.

The digital sample colours differ from the originals.
You can find our current fabric collection in our media center.

Table legs

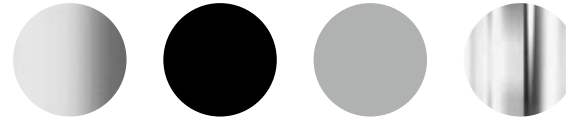

Clear anodised, black or silver-coated matt satin finish (Round tubing also chrome-plated aluminium)

Palette. 640 range. Edge shapes.

Wilkhahn



Straight edge, table top 39 mm (1 1/2") thick

Palette. 640 range. Accessories and other items.

Wilkhahn



Cable basket and table leg with cable outlet.



Square table leg with integrated techni-station.



Can be customised and dismantled at any time: the modular CableExpress power supply system in Palette offers perfect cable management.

646/01 Four-wheeled trolley

for 5 table tops 90 x 90 and/or 90 x 180 and 14 square table legs

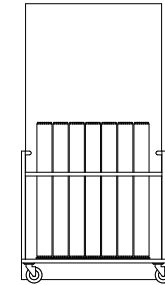
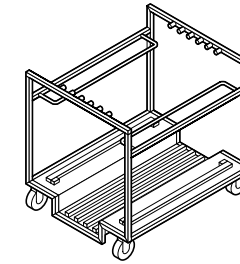

96

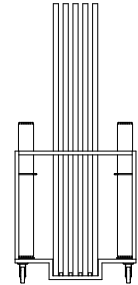

80

90

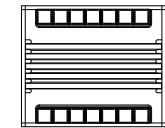

80

646

96

Palette. 640 range. Accessories and other items.

Wilkhahn



Integrated techni-station Basic



Integrated techni-station Basic



Single table portal Executive



Single table portal Executive



Integrated techni-station Rotate



Integrated techni-station Rotate



Single table portal Basic



Single table portal Basic



Integrated techni-station Move



Integrated techni-station Compact



Cable outlets



Socket strips

Please see the price list regarding integration of the techni-stations based on table models.

Palette. 640 range. Models and dimensions.

Wilkhahn

640 Palette

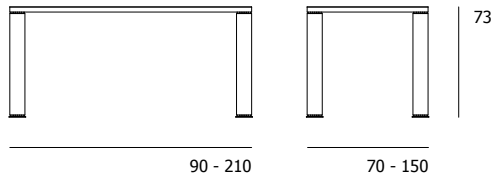
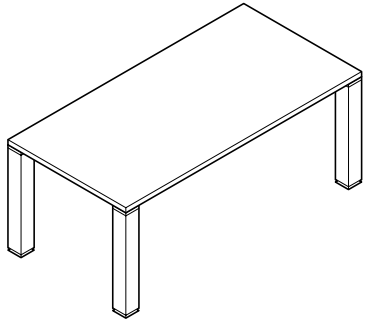

641
Frame leg for
73cm table height
Square

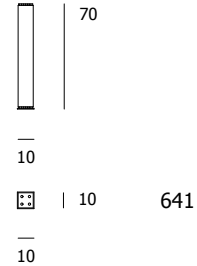

643
Frame leg for
73cm table height
Round



640/00
System panels
Table top
Rectangular

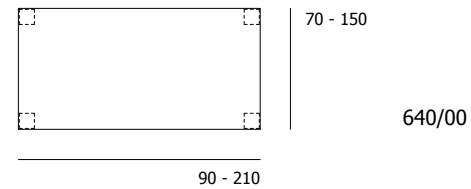

Palette. 640 range. Models and dimensions.

Wilkhahn

640/10
System panels
Extension leaf
Corner element 90°

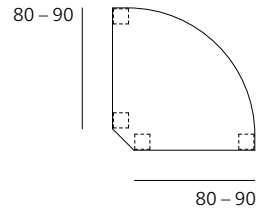

640/11
System panels
Extension leaf
Arc-shaped module 45°

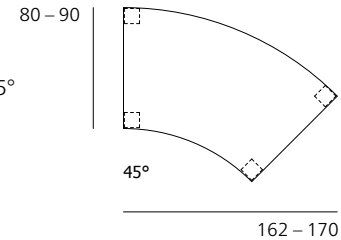

640/71
System panels
Starter table top panel
Semi-oval

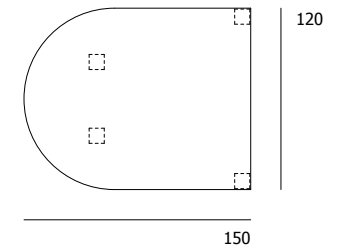

640/11
System panels
Extension leaf
Arc-shaped module 30°

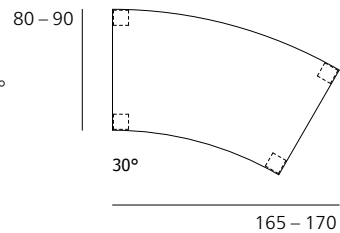

640/11
System panels
Extension leaf
Arc-shaped module 90°

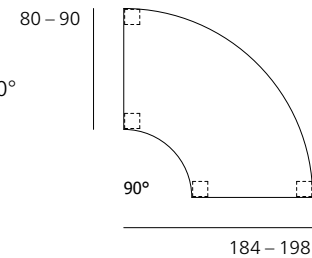

640/81
System panels
End table top panel
Semi-oval

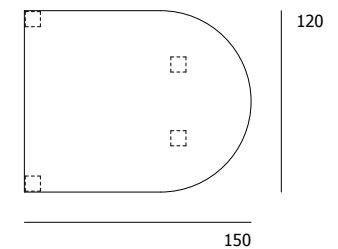

Palette. 640 range. Models and dimensions.

Wilkhahn

644/51
Table configurations
Starter table top panel
Semi-barrel shape

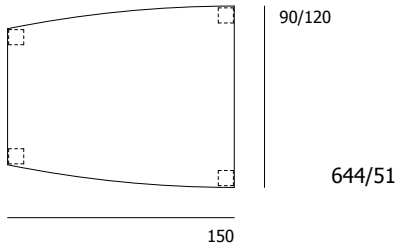

644/61
Table configurations
End table top panel
Semi-barrel shape

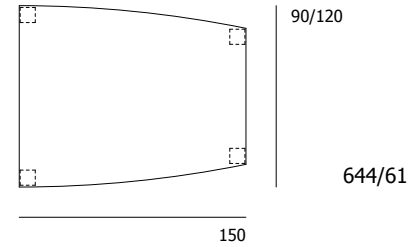

644/71
Table configurations
Extension leaf
Rectangular

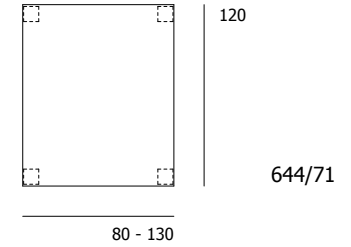

644/11
Table configurations
Starter table top panel
Semi-circle

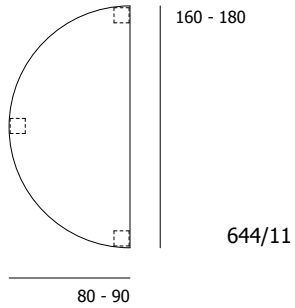

644/21
Table configurations
End table top panel
Semi-circle

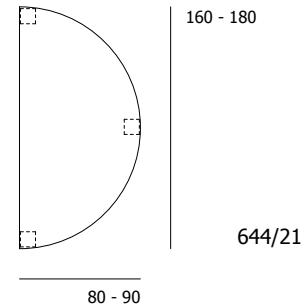

644/31
Table configurations
Extension leaf
Rectangular

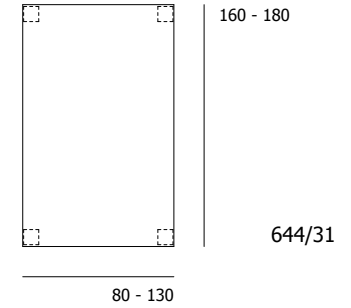

645/51
Table configurations
Starter table top panel
Semi-barrel shape

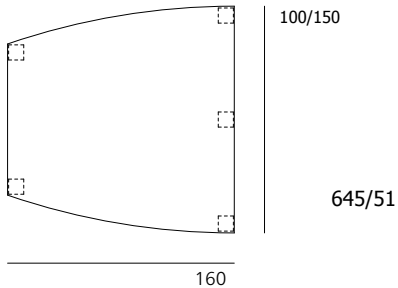

645/61
Table configurations
End table top panel
Semi-barrel shape

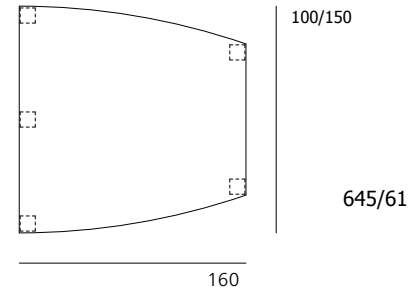

645/71
Table configurations
Extension leaf
Rectangular

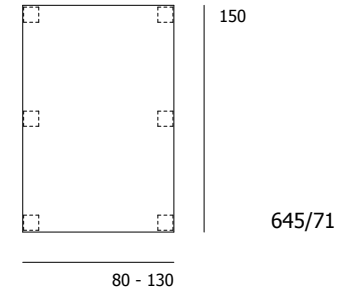

Palette. 640 range. Models and dimensions.

Wilkhahn

641/11
Table configurations
Extension leaf
Arc-shaped module 30°

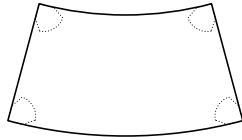

641/11
Table configurations
Extension leaf
Arc-shaped module 45°

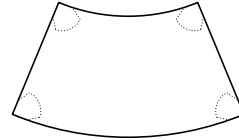

641/11
Table configurations
Extension leaf
Arc-shaped module 90°

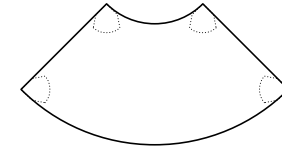

Palette. 640 range. Models and dimensions / example configurations.

Wilkhahn

16 people
6 x 640/00, 150x80
2 x 640/11, 80x177, 90°

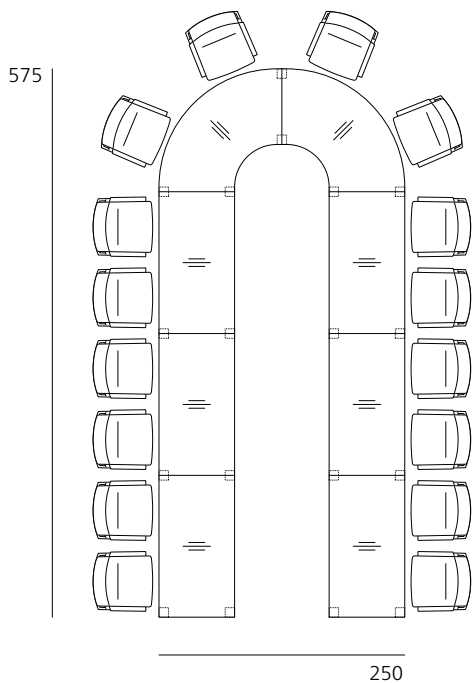

18 people
6 x 640/00, 160x80
2 x 640/00, 90x80
4 x 640/10, 80x80

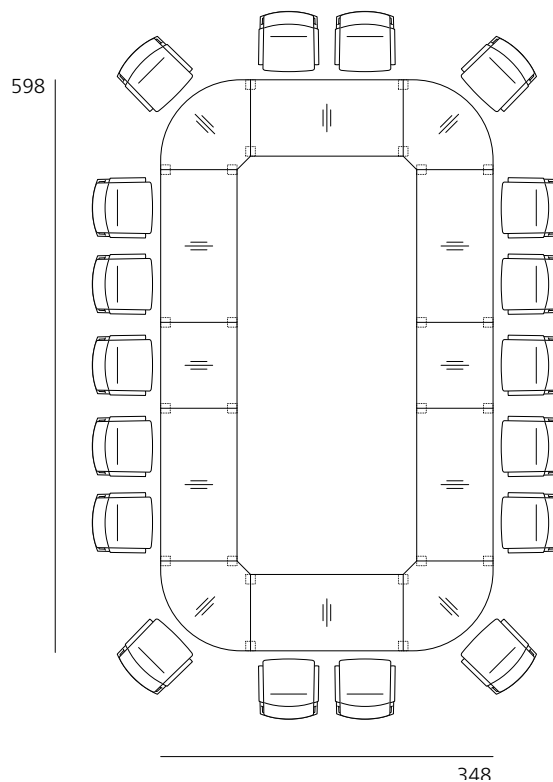

20 people
4 x 640/00, 150x150

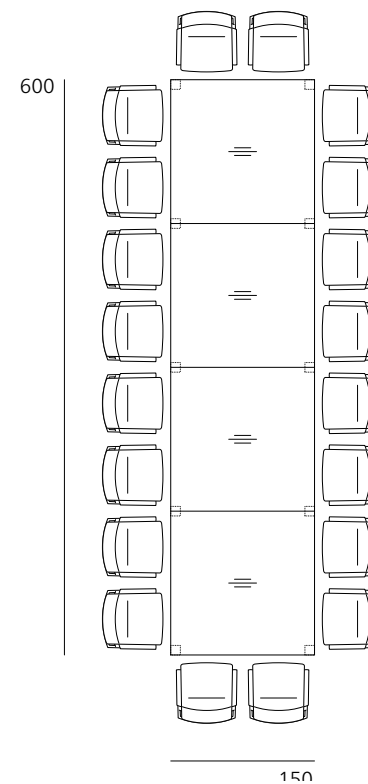

Palette. 640 range. Models and dimensions / example configurations.

Wilkhahn

14 people

4 x 640/00, 150x80
3 x 640/11, 80x153, 45°

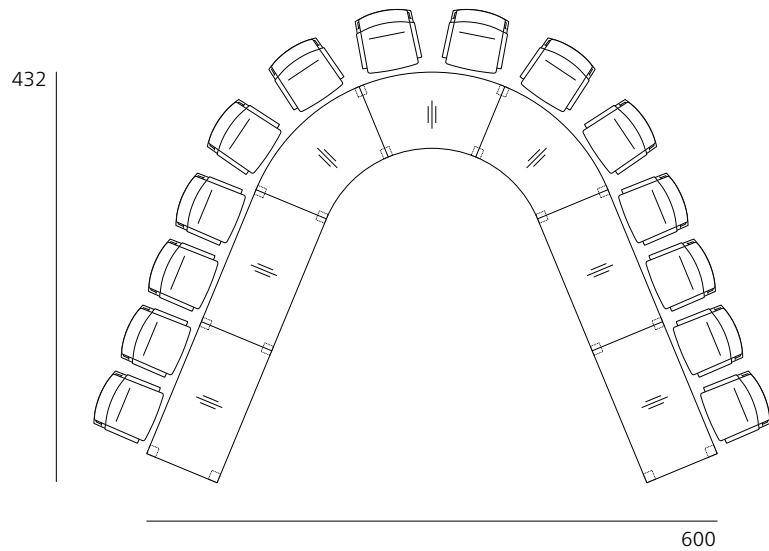

16 people

1 x 640/00, 120x210
1 x 640/71, 120x150
1 x 640/81, 120x150

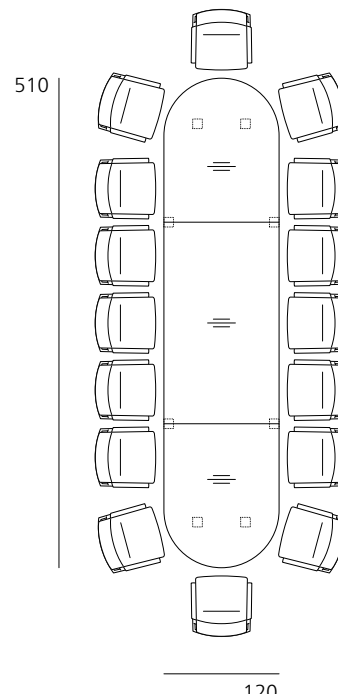

16 people

8 x 640/11, 80x155, 30°

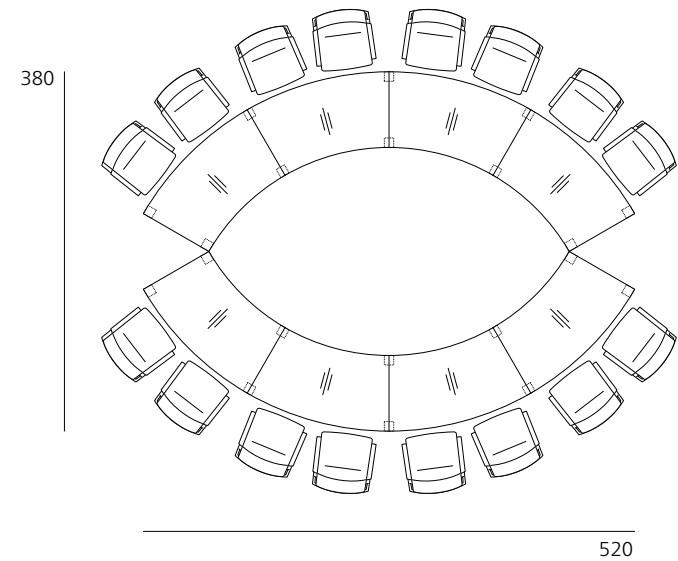

Palette. 640 range. Models and dimensions / example configurations.

Wilkhahn

16 people
8 x 641/11, 80x155, 30°

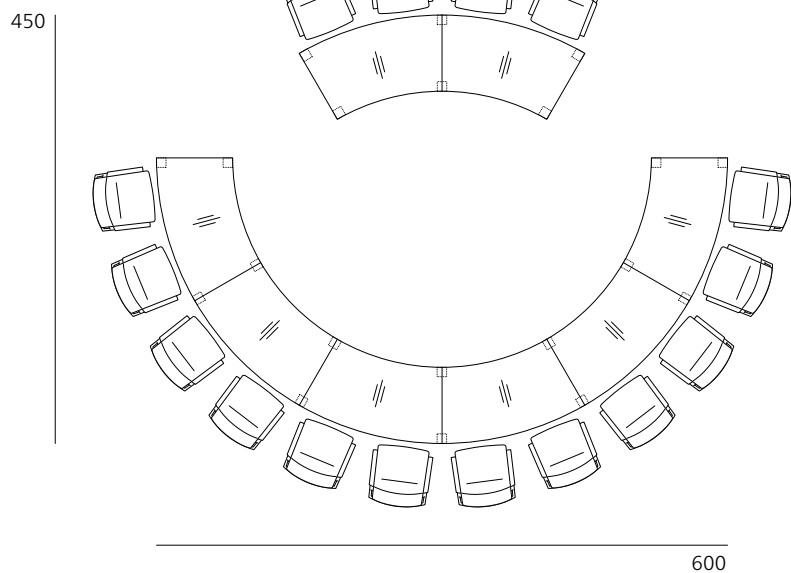

12 people
4 x 641/11, 80x177, 90°

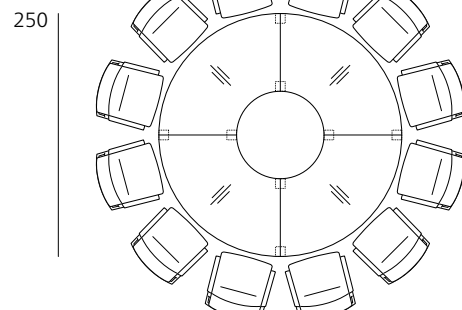

24 people
12 x 641/11, 80x155, 30°

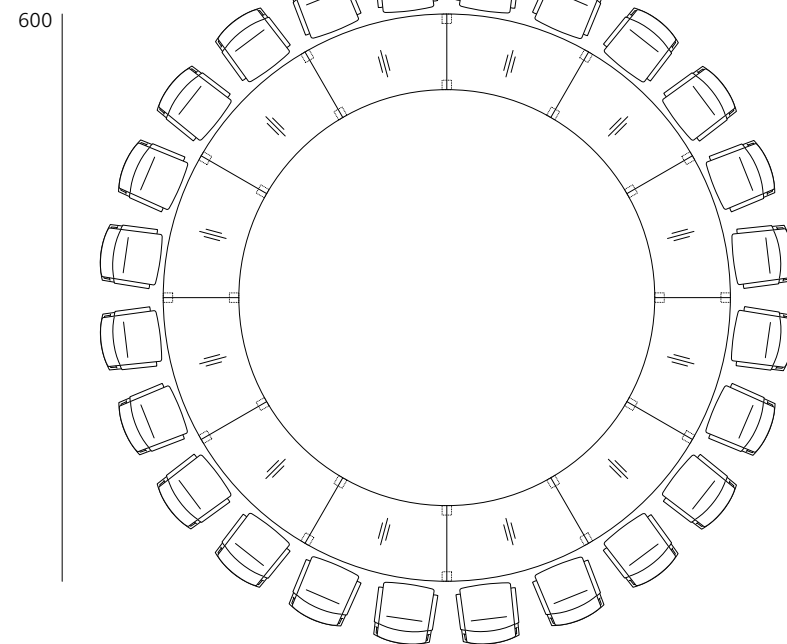

Palette. 640 range. Models and dimensions / example configurations.

Wilkhahn

16 people
8 x 641/11, 80x153, 45°

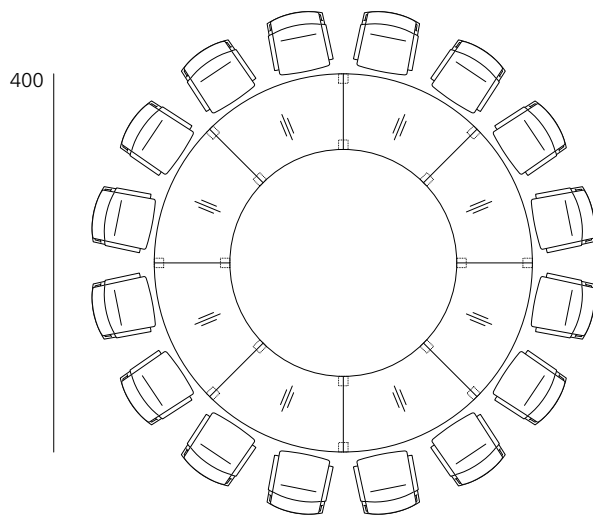

14 people
1 x 644/11, 180x90
1 x 644/21, 180x90
5 x 644/31, 180x90

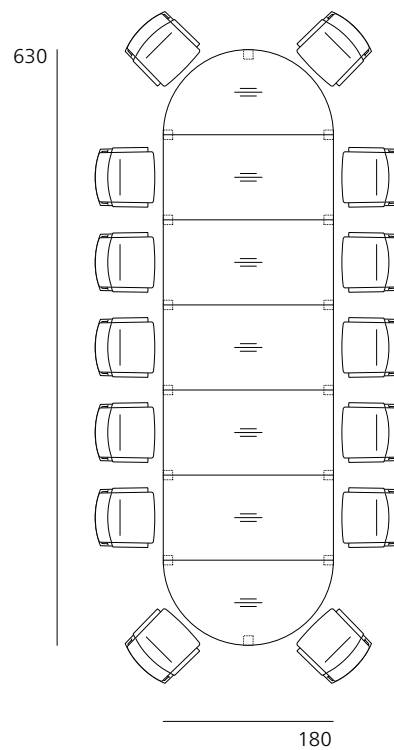

22 people
1 x 645/51, 100/150x160
1 x 645/61, 100/150x160
3 x 644/71, 150x130

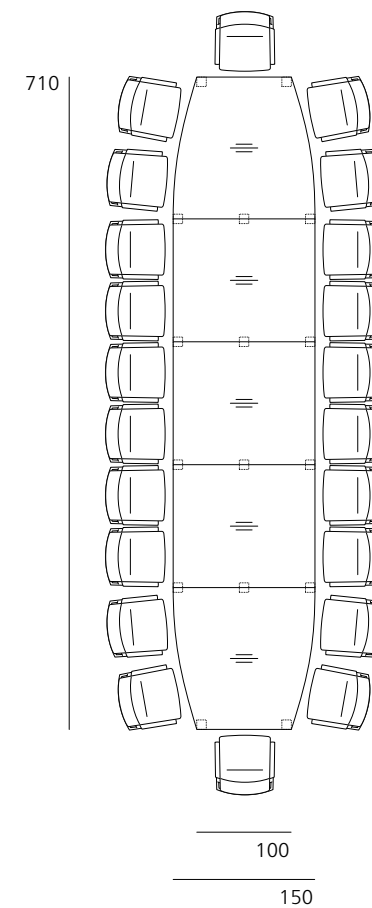

10 people
1 x 644/51, 90/120x150
1 x 644/61, 90/120x150

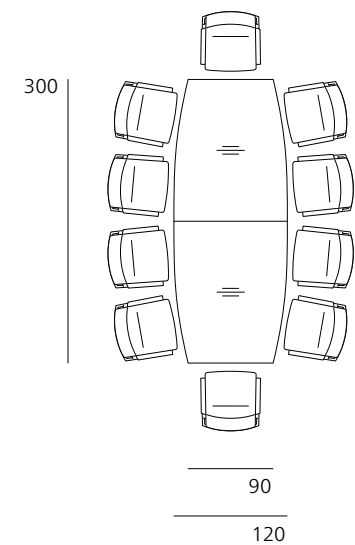

Palette. 640 range. Awards / standards / certificates.

Wilkhahn

Awards



Product certificates / product standards



ANSI/BIFMA X5.5

Company's certificates, memberships



Environment and product

High-quality tables built to last with future-proof versatility

The understated design conveys the sort of quality that looks set to endure and means that the table can be used for an almost unlimited period of time too. Each and every table and module is always ready to take on a new role. Wilkhahn only uses hard-wearing materials to ensure the quality fulfils what the design promises:

- The table tops consist of bend-resistant lamin board whose core is created from vertically bonded solid wood strips; the robust lipping is also made of renewable solid wood. As a result the table requires no underframe or frame.
- Natural materials such as linoleum, laminates and genuine wood veneers are applied for the surfaces. Veneered table tops are protected with water-based varnish low in solvent content.
- Some of the table legs made of aluminium extruded profile and the steel locking mechanism consist of materials that have already been recycled and can be recycled again after a long service life. Palette is exceptionally repair-friendly because we only use mechanical connections that are very easy to release.

After 17 years on the market, Palette is now considered a classic piece of furniture among the versatile table ranges. Should table tops show unwanted signs of wear and tear after a long period in use, Wilkhahn can refurbish or replace them.