

Wilkhahn

Confair folding table.
440 range.





Confair folding table.

Dynamic. Space-saving.
Superbly designed.

Thanks to Confair folding tables, versatile usage of well-designed conference and meeting areas is child's play. Only one single person is required to set up and rearrange the moveable folding tables – without any tools, releasing or unlocking procedures or special skills involved. Snap connectors allow the tables to be linked in any direction. If partitions are used to divide up rooms, conference or project work tables can be transformed into a large conference layout in no time. It is a welcoming thought that investing in Confair folding tables pays for itself so quickly...

The sophisticated folding technique and the large lockable wheels, as well as the elegant design and high-quality materials, are equally responsible for the table's success. The table's structure makes it simple to use and transport. The look of the table reflects communication at a high level: from the conference and project-work room, to executive offices. As options, cable channels, power supply connections and innovative techni-modules ensure interactive access to state-of-the-art multi-media equipment is so easy it has to be believed. The table is the perfect mix of well-used space, aesthetic appeal and advanced technical functions.



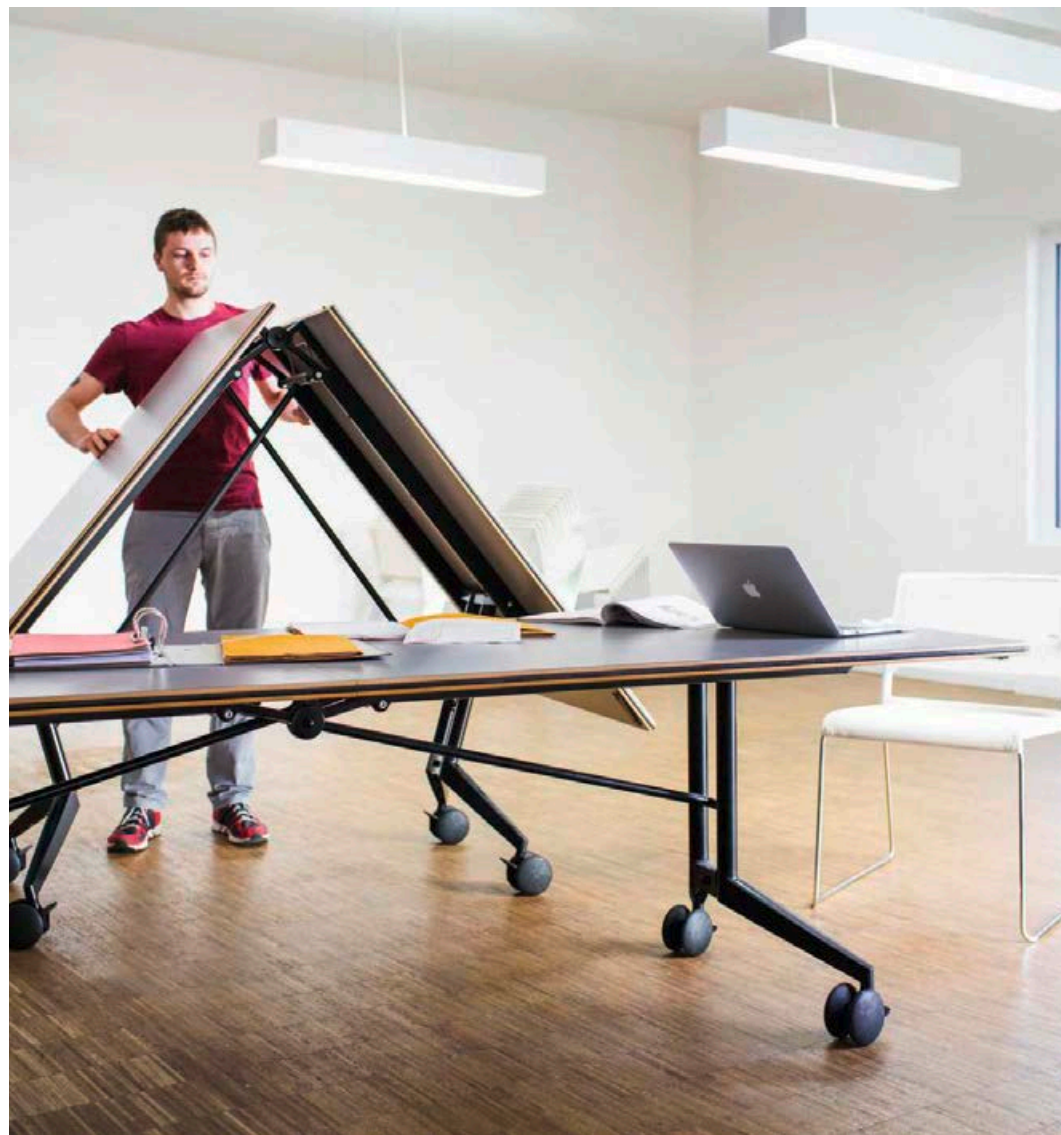
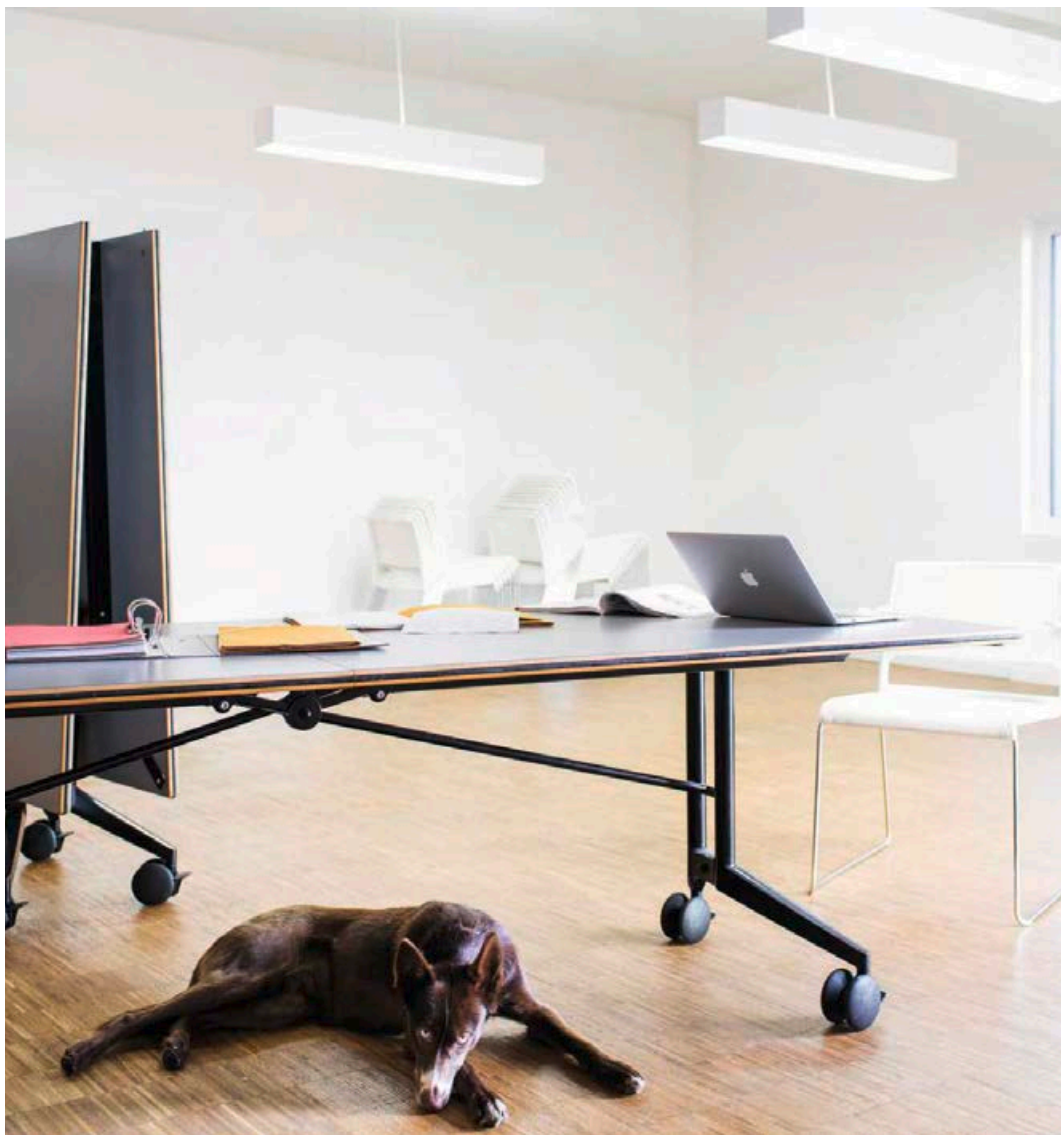

Confair folding table. 440 range. Technical details.

Wilkhahn

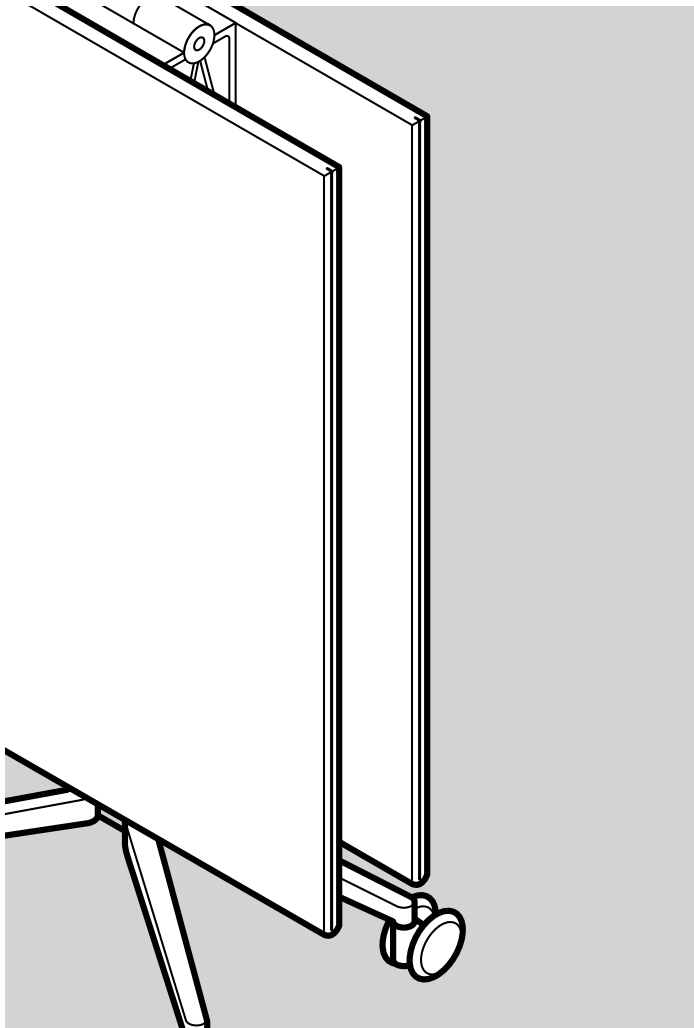

Function

Mobile, fold-up and linkable table range for dynamic use of conference and communication areas that users can set up themselves. Just one single step is required to open out or collapse up to three metre long, barrel-shaped or rectangular tables. The tables can also be linked to form conference systems using table-table connectors. Large-sized castors allow the tables to be transported in buildings. A brake locks them in place. As a result, minimum cost and effort is required to manage conference spaces. Ideal for multipurpose conference interiors in high-quality design. Alternatively as a wild card in combination with the Logon table range for conference spaces with a variety of partition options, or with Timetable for sophisticated training and seminar spaces.

Frame

Foot section in die-cast aluminium, bright chrome-plated, polished or coated in a silver satin finish or black. Aluminium profile uprights and underframes, clear anodised or coated in the same colours as the foot sections. The bright chrome-plated foot sections are coated black. Uprights optionally available as bright chrome-plated versions. Connecting bar and T-shaped joint coated like the uprights and underframes, clear anodised uprights and underframes are coated in a silver satin finish. Connecting bar and T-shaped joint optionally bright chrome-plated. Lockable, black polyamide castors.

Core material of table top

Laminboard with bullnose double, concealed lipping with integrated impact-resilient profile in black elastomer. Straight version of table top without any profile along central joining edge.

Table top group 1 – laminate

Table top thickness 26 mm Laminate based on Wilkhahn colour and surface finish samples with laminated beech lipping, natural oiled finish

Table top group 2 – veneer

Table top thickness 26 mm Variant 1: Beech veneer according to Wilkhahn woodstain colour samples with laminated beech lipping, or oak or ash veneer according to Wilkhahn woodstain colour samples with lipping, mostly colour matched with the veneer. Variant 2: Maple, elm or walnut veneer, as well as Wilkhahn Mocca veneer from the Wilkhahn woodstain colour samples with lipping colour matched as far as possible with the veneer.

Veneer types

As a standard, the veneer panels are slip-matched. Surfaces sealed with clear lacquer: open-pore: oak, ash, walnut and elm veneer, as well as Wilkhahn Mocca veneer closed-pore: maple and beech veneer. Some specific growth features possible.

Table top group 3 – linoleum

Table top thickness 27 mm Linoleum from the Wilkhahn woodstain colour samples, with laminated beech lipping, natural oiled finish

Standards

The Confair folding tables comply with the ANSI/BIFMA X 5.5 standard.

When placing repeat orders, please indicate whether your table tops have slip-matched or book-matched veneer.

Edge profiles



Bullnose double with integral, impact-resilient profile

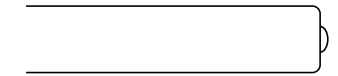

Straight with integral, impact-resilient profile

Confair folding table. 440 range. Product versions.

Wilkhahn



Frame: fully coated in silver, satin finish, table top natural oak

Frame: polished aluminium, clear anodised, linoleum table top

Table top groups

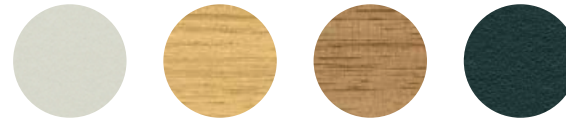

Laminate, veneer type 1 or 2, linoleum, you can find further surfaces in our media center.

Laminate. The material is made by bonding cellulose and décor paper layers, as well as resin, by applying heat and pressure. This produces an extremely tough surface that comes in a variety of different colours. Laminate is highly recommended for areas where the tables are subject to a lot of wear and tear because they are frequently moved around for example.

Wood veneers. Natural wood is a living material: in the way it looks and changes over the years. Sometimes more significantly and sometimes more subtly, depending on the type of wood and how light it is. If a more consistent look is preferred, stained surfaces or industrially produced veneer (e.g. mocha) are available.

Linoleum. The material consists of linseed oil and natural resin that is applied to a backing layer and protected with a matt-glossy lacquer. In terms of haptics, it is not just extremely pleasant, but is naturally anti-static too. Virtually no finger prints or dust stick to the surface. Over the years linoleum table tops gain a characteristic patina.

Foot section and upright



Bright chrome-plated or polished aluminium, coated in black or in a silver, satin finish (uprights not polished, but available as clear anodised versions)

The digital sample colours differ from the originals. You can find our current fabric collection in our media center.

Confair folding table. 440 range. Table edges.

Wilkhahn

Edge profiles

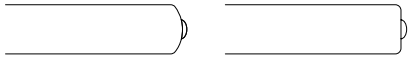

Standard type: bullnose with integrated impact-resilient profile
Alternatively: straight with integrated impact-resilient profile

Bullnose edge with a black impact-resilient profile, table top 26 mm thick



Bullnose edge with a white impact-resilient profile, table top 26 mm thick



Coated bullnose edge with a black impact-resilient profile, table top 26 mm thick



Straight edge with a black impact-resilient profile, table top 26 mm thick



Straight edge with a white impact-resilient profile, table top 26 mm thick



Confair folding table. 440 range. Accessories.

Wilkhahn



Integrated techni-station Basic



Integrated techni-station Basic



Single table portal Executive



Single table portal Executive



Integrated techni-station Rotate



Integrated techni-station Rotate



Single table portal Basic



Single table portal Basic



Integrated techni-station Move



Integrated techni-station Compact



Cable outlets



Socket strips

Please refer to the price list if you would like to integrate the techni-stations based on table models.

Confair folding table. 440 range. Models and dimensions.

Wilkhahn

440/00

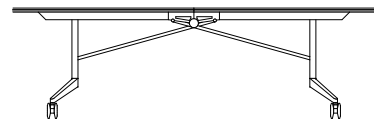
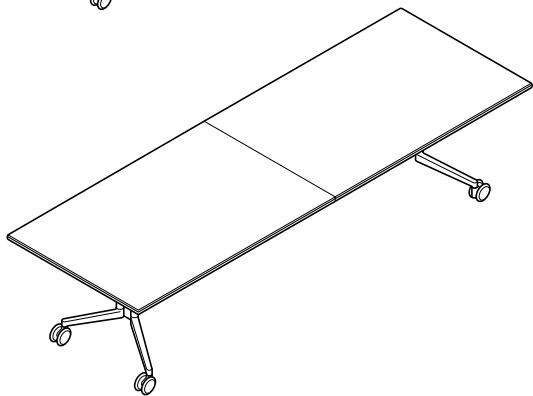
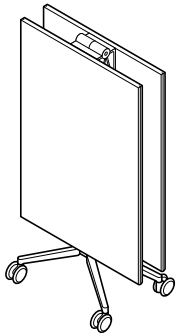

180 - 300

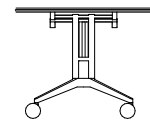

90 - 120

73

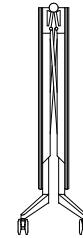

56

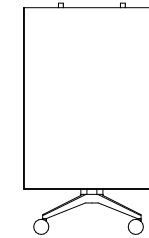

90 - 120

120 - 180

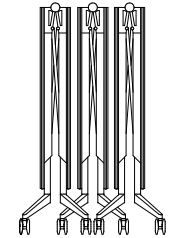

97

120 - 180

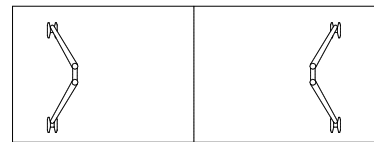

90 - 120

440/00

180 - 300

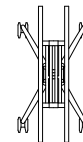

56

90 - 120

440/00

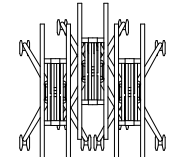

97

105 - 135

	Depth				
Width	90	100	105	110	120
180	•	•	•	•	•
200	•	•	•	•	•
210	•	•	•	•	•
220	•	•	•	•	•
240	•	•	•	•	•
260	•	•	•	•	•
280	•	•	•	•	—
300	•	•	—	—	—

All dimensions in cm.
Subject to change.

Confair folding table. 440 range. Models and dimensions.

Wilkhahn

440/2

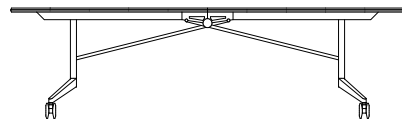
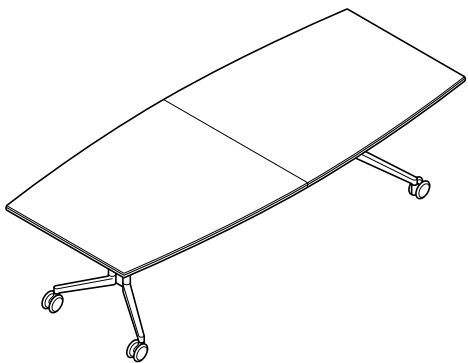
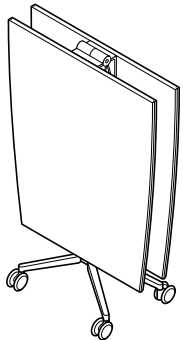

180 - 280

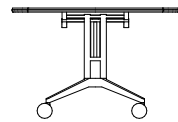

90/110 - 120

73

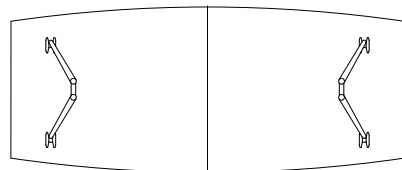

90/110 - 120

440/2

180 - 280



56

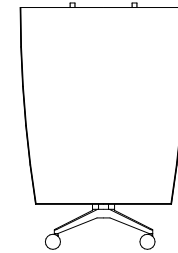

110 - 120

120 - 170

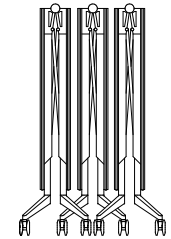

97

120 - 180

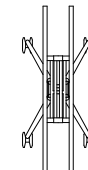

56

110 - 120

440/2

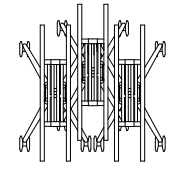

97

105 - 135

	Depth	
Width	90/110	90/120
180	—	•
240	—	•
260	•	•
280	—	•

Confair folding table. Programm 440. Models and dimensions / example configurations. **Wilkhahn**

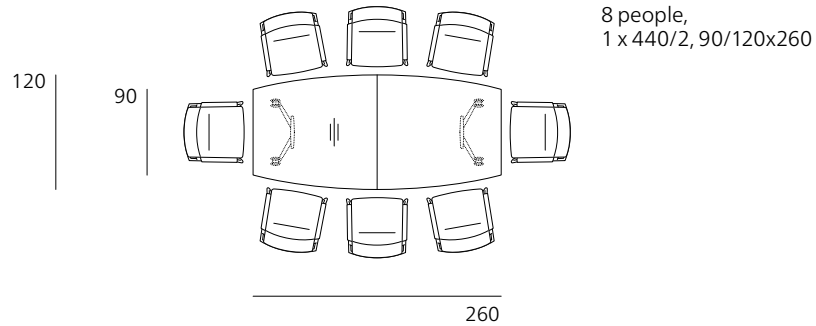

18 people,
6 x 440/00, 90x210

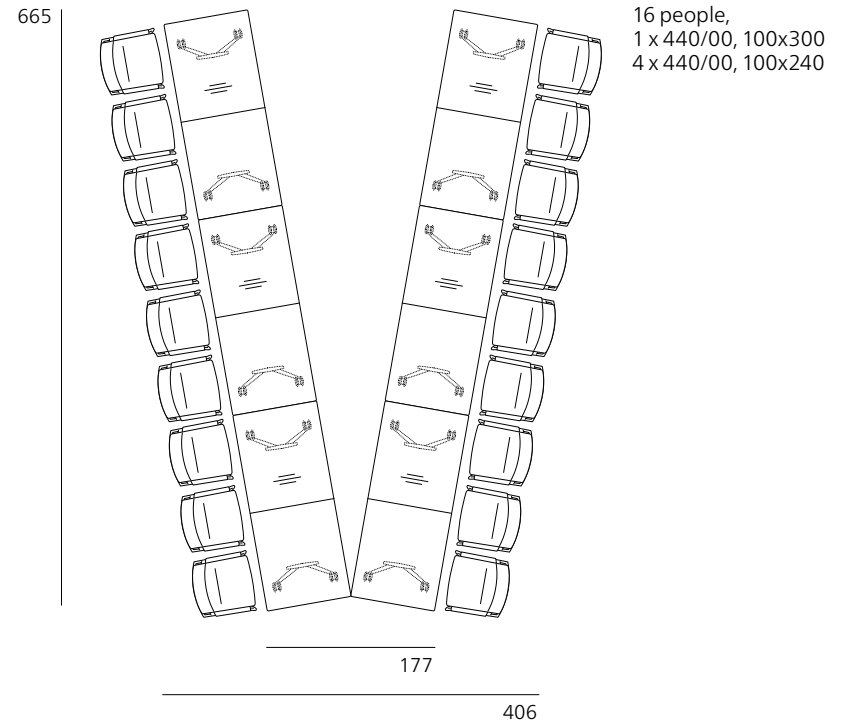
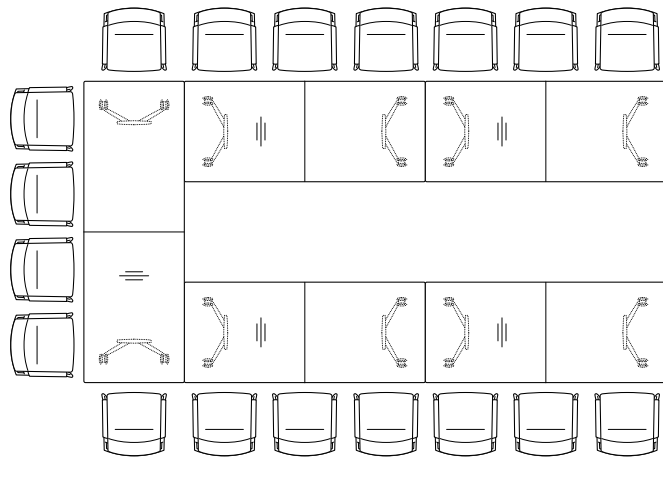

Confair folding table. Programm 440. Models and dimensions / example configurations.

Wilkhahn

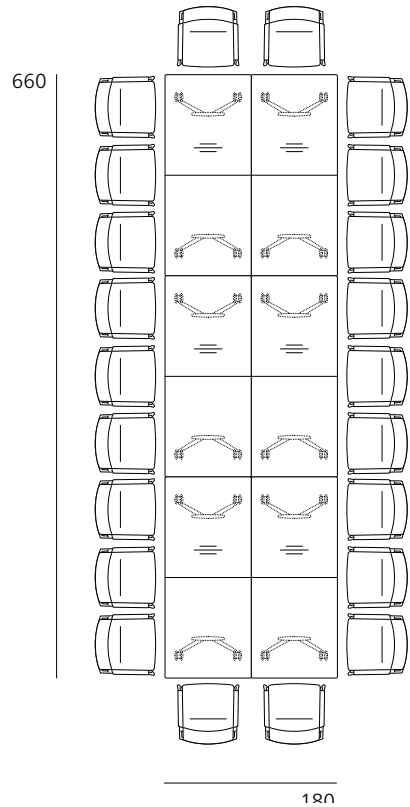

22 people,
6 x 440/00, 90x210

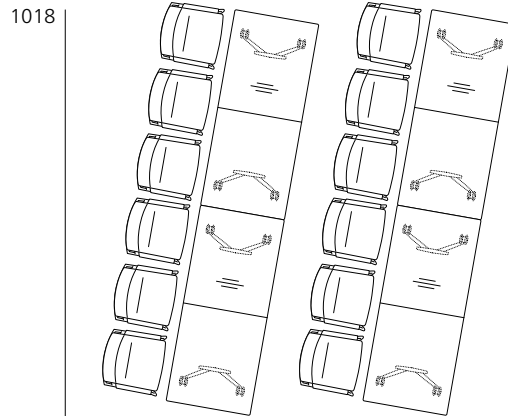

24 people,
8 x 440/00, 90x210

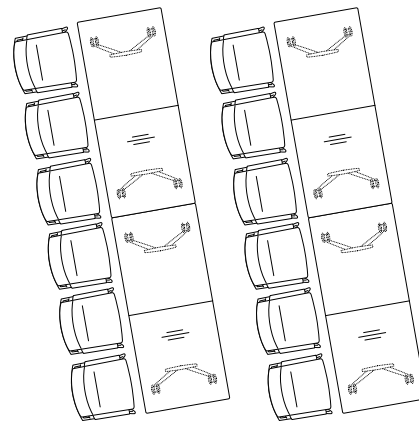

28 people,
8 x 440/00, 90x210

Confair folding table. 440 range. Awards / standards / certificates.

Wilkhahn

Awards



Product certificates / product standards



ANSI/BIFMA X5.5

Company's certificates, memberships



Environment and product

Better use of space, selective sorting, service-friendliness

The Confair range is an impressive example of how intelligent design, smart functionality and quality can achieve financial, ecological and socio-cultural improvements. Encouraging people to become involved in shaping their own environments puts the focus on them personally and their potentials. The range is easy to handle and allows people to organise their own spaces, saving facility management costs as well as building and maintaining extra rooms. Wilkhahn's eco-based design principles combine a long product life with a careful choice of materials, as well as a repair- and service-friendly design. The Confair folding table is a perfect example:

- All components like the foot section, uprights and underframes are made of die-cast aluminium and extruded aluminium profiles and with the steel mechanical spring they combine an adherence to tolerances with extreme durability and full recycling capabilities. All the four lockable castors of unbreakable and through-dyed polyamide are designed to be hard-wearing.
- The table tops are made of lamin board with solid-wood edges. Natural materials like linoleum, laminates and genuine wood veneers are used for the surfaces. Veneered table tops are protected with water-based varnish low in solvent content. The integrated polypropylene impact-resilient profile protects the edges and prevents damage.
- All frame components and table tops are screwed together so that if wear and tear occurs – for example on the table tops – the panels can be unscrewed, reconditioned or replaced. The Confair range has opened up new opportunities for designing, furnishing and using conference spaces so that material and energy are saved. Apart from the durability and quality of the product, these aspects also help to improve a building's eco footprint overall.

You can find our environmental product information in our media center.