

Wilkhahn

Aline tables. 230 range.





Aline tables.

Tables for multipurpose areas.

In addition to bar stools, multipurpose and task chairs, the Aline range also offers round and square low, sitting and standing-height pedestal tables, as well as two-pedestal rectangular tables. The stylish and transparent look and feel of Aline is ideal for informal areas used for professional purposes: sales rooms, customer-support and waiting areas, bistros and cafeterias, or desks and dining rooms at home. Thanks to the anti-bacterial fabric of the seating and the easy-care, robust table tops, Aline is an excellent choice for spas and healthcare areas. Whatever the setting, the furniture lends the room a light and informal appeal that encourages impromptu chats. It is both attractive and comfortable with sophisticated functions at the same time.





Aline tables. 230 range. Technical details.

Wilkhahn

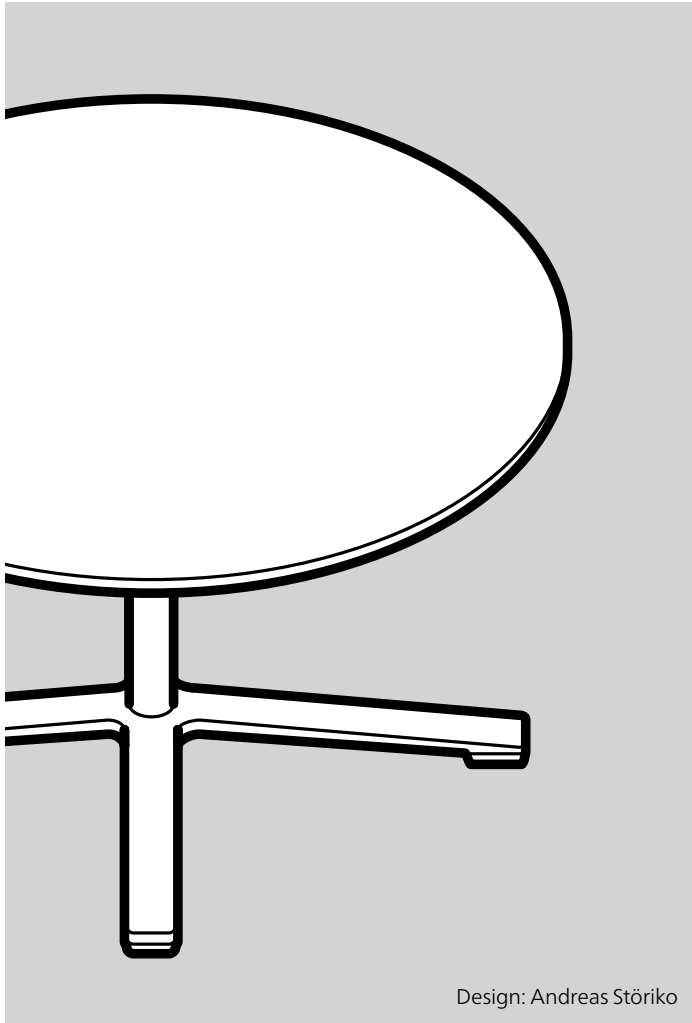

Design: Andreas Störiko

Function

Stylish and coherently designed, multipurpose furnishing range for meetings, consultations and seminars, in showrooms and event spaces, areas for breaks, lounges and bistros, as well as libraries, internet cafés or home offices.

Tables

Square and round-top column tables in low, sitting and standing heights (optionally stackable) and rectangular tables on a T-shaped base for waiting and recreational areas, cafeterias and bistros.

Frame

Models 235/236

Four-star base in die-cast aluminium, bright chrome-plated, with glides in black polyamide (for soft floors) or black polyurethane (for hard floors), optionally with additional felt insert. Table column made of tubular steel 4 mm thick, 40 mm in diameter, for side-table, sitting- and standing-heights (45/73/105 cm), to match the table top and coated black or white, with round steel flange, coated black, in the version where tables nest into one another with extra glide- and impact-protection, slip-free separator and docking guide each in black plastic.

Model 237/00

Unitary, die-cast aluminium foot section, optionally bright chrome-plated, or coated in black or white. Black polyamide glides (for soft flooring), or black polyurethane (for hard flooring), optionally with additional felt insert. Aluminium upright to match the table top, black or white coated, or optionally bright chrome plated. Underframes made of rectangular steel tubing with flange, coated black or white depending on the foot section. Coated black in the case of a bright chrome-plated foot section.

Core material of table top models 235/236/237

Table top made of through-dyed HPL (High Pressure Laminate) in black or white. Each table top is 12 mm thick.

Models 235/236 in sizes: 60 x 60 cm (where table heights are 45 and 105 cm) or 70 x 70 cm (where table height is 73 cm) or round, 75 cm in diameter (where table heights are 45 and 73 cm) or 70 cm (where the table height is 105 cm).

237 models in the following sizes: (Table height 73 cm) 70 x 140 cm 75 x 150 cm 80 x 160 cm 90 x 180 cm 90 x 200 cm

In the version with veneer (on request): MDF (medium density fibre-board) panel only in combination with veneered surface finish with colour-matched, chamfered wood lipping (with a radiused edge). Exception: maple or ash with natural finishes are not available.

Aline tables. 230 range. Technical details.

Wilkhahn

Table top group 2 – veneer

Thickness 20 mm Variant 1: Beech, oak and ash veneer from Wilkhahn woodstain colour samples with wooden lipping, as far as possible in the same colour as the veneer Variant 2: Walnut or elm veneer, as well as Wilkhahn Mocca veneer from the Wilkhahn woodstain colour samples with wood lipping as far as possible in the same colour as the veneer.

Veneer types

As a standard, the veneers are made by slip-match method. Surfaces sealed with clear lacquer: open-pore: oak, walnut and elm veneer, as well as Wilkhahn Mocca veneer closed-pore: beech veneer. Some specific growth features possible.

Tables

Round column tables in four different formats (Ø 90 – 140 cm) for large conferences, meetings or as home dining tables.

Frame

Frame models 237/2, 4, 5

Steel disc base (Ø 610 mm) with sheet steel cover, coated in white or black, or with optional ultra-polished stainless steel cover.

Tubular steel table column (80 mm in diameter), white or black coated, optionally bright chrome-plated. Rectangular tube table top bearer, coated in black.

Frame model 237/6

Steel disc base (735 mm in diameter) with sheet steel cover, coated in white or black, or with optional ultra-polished stainless steel cover. Tubular steel table column (80 mm in diameter), coated white or black, optionally bright chrome-plated. Rectangular tube table top bearer, coated in black.

Core material of table top models 237/2, 4, 5, 6

MDF table top (medium density fibreboard), white, or black powder-coated with chamfered edge. Each table top is 25 mm thick.

Aline tables. 230 range. Product designs.

Wilkhahn



235/1 Low table
Square 60 x 60 cm
Height 45 cm



235/2 Table
Square 70 x 70 cm
Height 73 cm



235/3 High table
Optionally nest into one another
Square 60 x 60 cm
Height 105 cm



236/1 Low table
Round Ø 75 cm
Height 45 cm



236/2 Table
Round Ø 75 cm
Height 73 cm



236/3 High Table
Optionally nest into one another
Round Ø 70 cm
Height 105 cm

Table column



Bright chrome-plated tubular steel, black or white coated

Uprights and foot sections

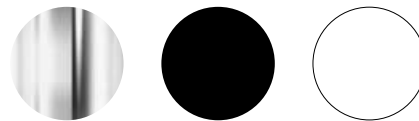

Bright chrome-plated aluminium, black or white coated

Base



Bright chrome-plated aluminium

The digital sample colours differ from the originals. You can find our current fabric collection in our media center.

Aline tables. 230 range. Product designs.

Wilkhahn



237/2 Table
Round Ø 90
Height 73 cm



237/4 Table
Round Ø 110
Height 73 cm



237/5 Table
Round Ø 125
Height 73 cm



237/6 Table
Round Ø 140 cm
Height 73 cm



237/00 Table
Rectangular
Depth 70–90 cm,
Width 140–200 cm
Height 73 cm

Disc base



Polished stainless steel, black or white coated

Table surfaces

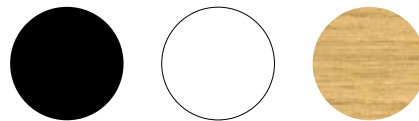

Black or white, veneer variation 1 or 2 on request

The digital sample colours differ from the originals.
You can find our current fabric collection in our media center.

Aline tables. 230 range. Models and dimensions.

Wilkhahn

235/1
Low table

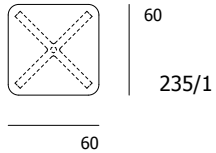
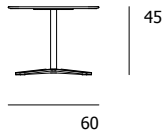

235/1

235/3
High table, does not nest into further tables

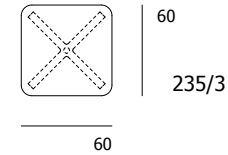
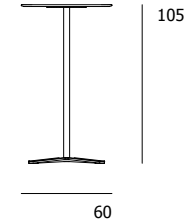
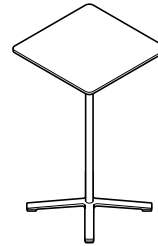

235/3

235/2
Table

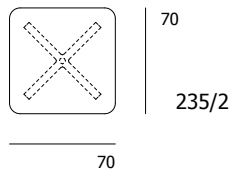
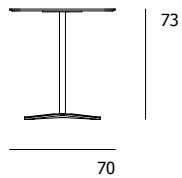
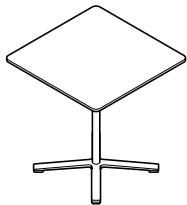

235/2

235/3
High table, will nest into further tables

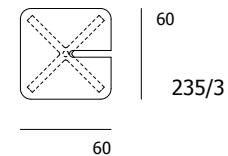
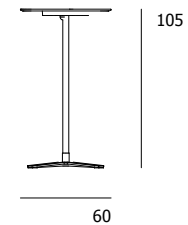
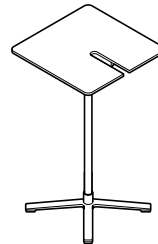

235/3

Aline tables. 230 range. Models and dimensions.

Wilkhahn

236/1
Low table

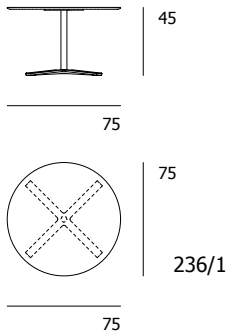

236/3
High table

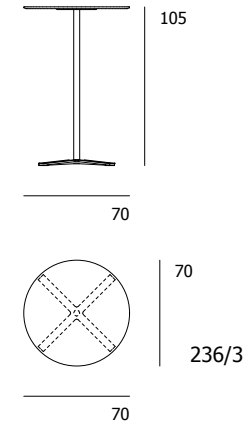
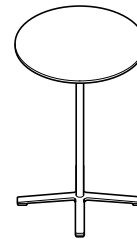

236/2
Table

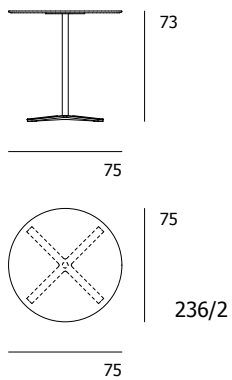

236/3
High table, nests into further tables

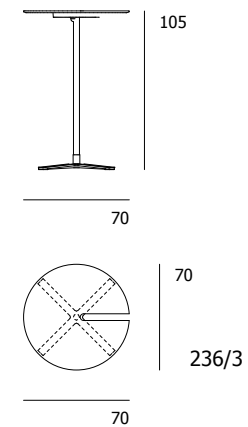
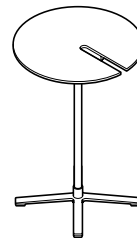

Aline tables. 230 range. Models and dimensions.

Wilkhahn

237/2
Table

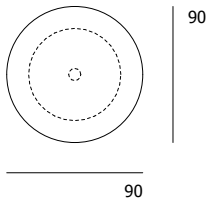
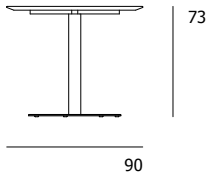
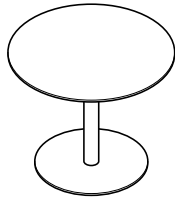

237/2

237/5
Table

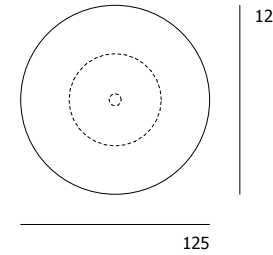
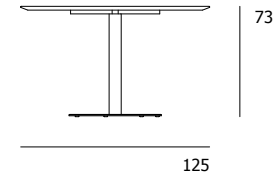
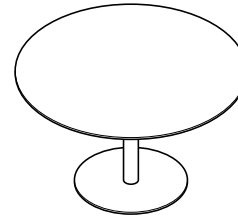

237/5

237/4
Table

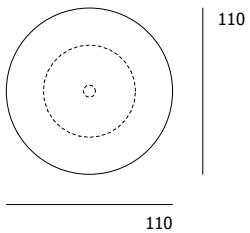
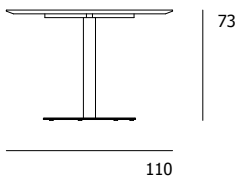
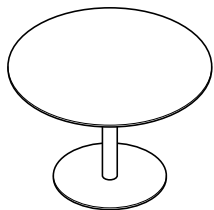

237/4

237/6
Table

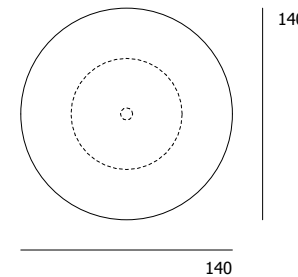
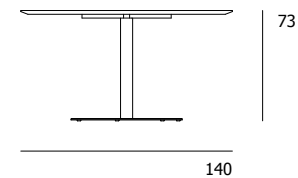
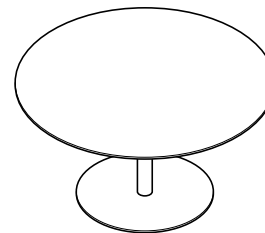

237/6

Aline tables. 230 range. Models and dimensions.

Wilkhahn

237/00
Table

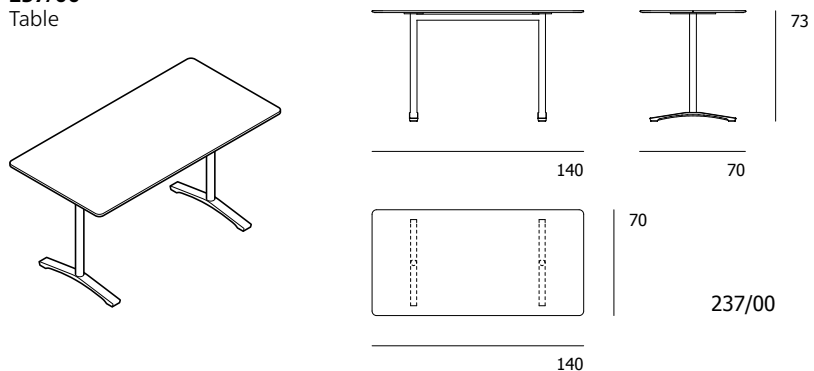

237/00
Table

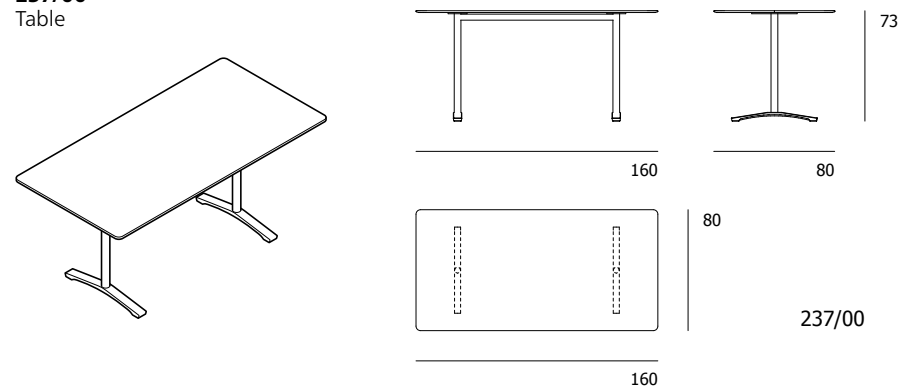

237/00
Table

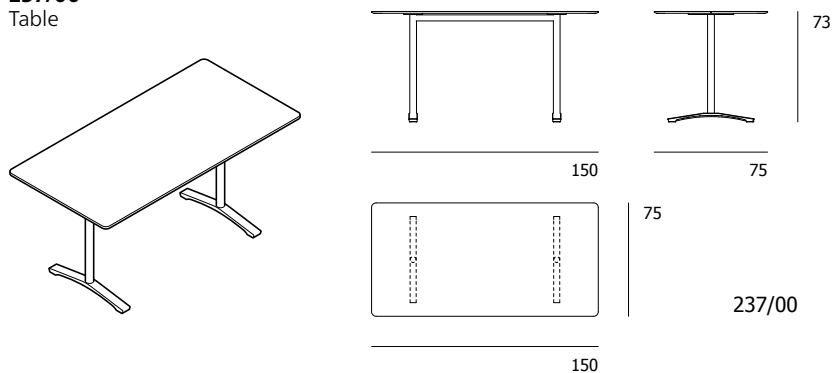

237/00
Table

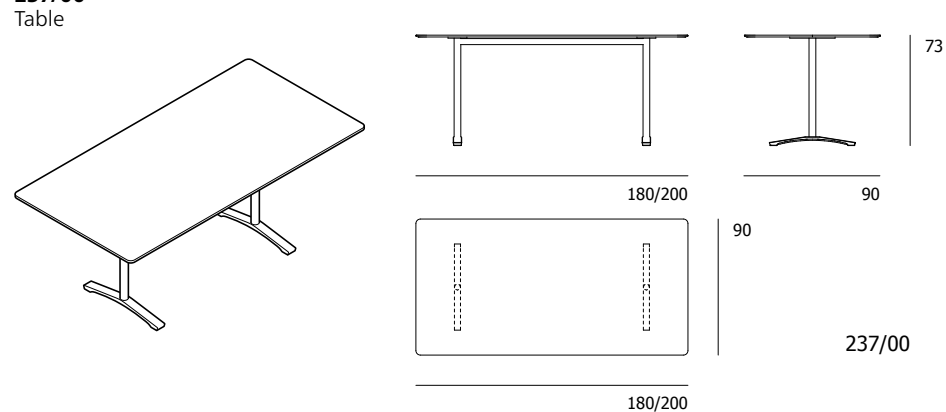

Aline tables. 230 range. Awards / standards / certificates.

Wilkhahn

Awards



Focus Energy Gold 2006

Product certificates / product standards



Company's certificates, memberships



Mitglied der DGNB Deutsche Gesellschaft für Nachhaltiges Bauen German Sustainable Building Council



The mark of responsible forestry