

Wilkhahn

Metrik. 186 range.

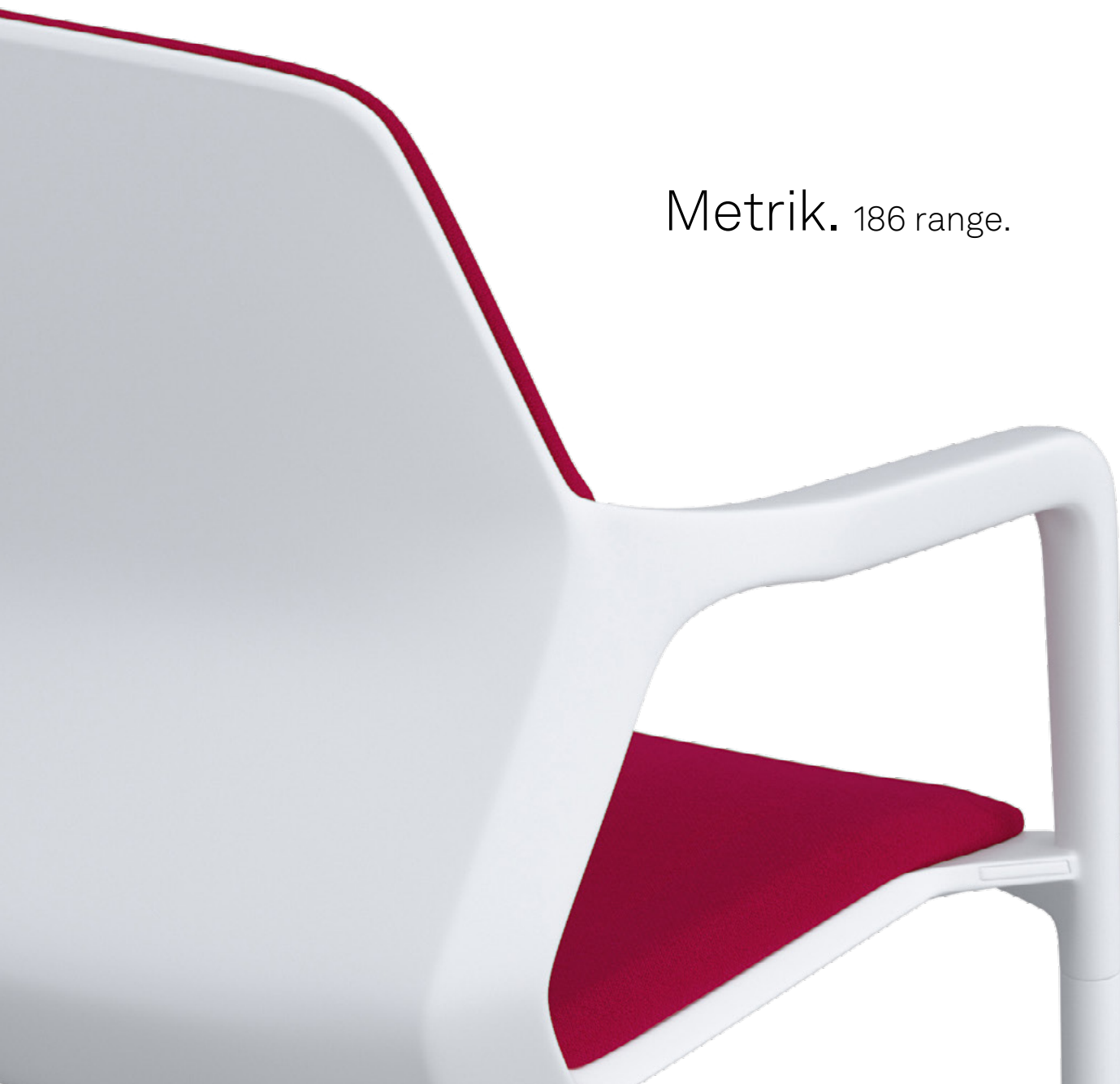



Metrik.

The Metrik cantilever chair stands apart for its sculptural shape. The different thicknesses of materials, polygonal areas and rounded edges are reminiscent of modern transportation design. It has taken until today to make such a complex structure from one piece of material. The seat and the tubular frame are the same colour to lend greater emphasis to the integrated design. The spacious shape of the inside of the chair with its integrated seat cushion offers ergonomic comfort which can be further enhanced by extra cushioning at the back. The distinct design and the range of colourways mean that Metrik can be seamlessly incorporated into a diverse range of design worlds and with a chrome-plated frame it's also stackable.

Design: whiteID







Photo: Tryingtodoart SRL, object: Nepi Rockcastle



Metrik. 186 range. Frame types.

Wilkhahn

Frame surfaces

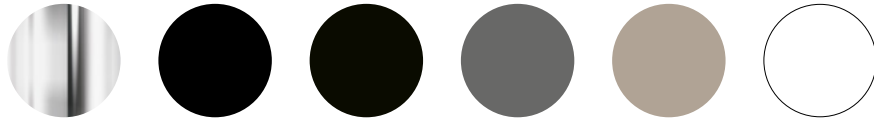

Bright chrome-plated tubular steel, black chrome-plated, coated black, grey, grey-beige or white with a textured matt finish

Seat and backrest shell



Black, grey, grey-beige, orange-red, blue-grey or white

You can find our current fabric collection in our media center

The digital sample colours differ from the originals.



Metrik. 186 range. Product types / upholstery types.

Wilkhahn



186/3 Cantilever chair with seat cushion



186/3 Cantilever chair with seat and back cushion

Upholstery material

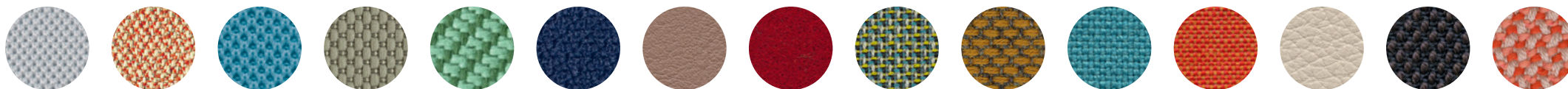

37 Racer | 38 Era | 41 Formstrick | 47 Nova | 51 Oceanic | 54 Pitch | 58 Evida | 60 Blend | 64 Morph | 65 Re-wool | 66 Lona | 68 Kvadrat Remix 2 | 74 Leather | 91 Kvadrat Steelcut Trio 3 | 92 Credo

You can find all upholstery materials and more colours in our media center

The digital sample colours differ from the originals.

Metrik. 186 range. Accessories and other items.

Wilkhahn

186 Four-wheeled trolley for 8 cantilevers



187 Inline connector
2 for bright chrome-plated frame



Metrik. 186 range. Models and dimensions.

Wilkhahn

186/3
Cantilever chair

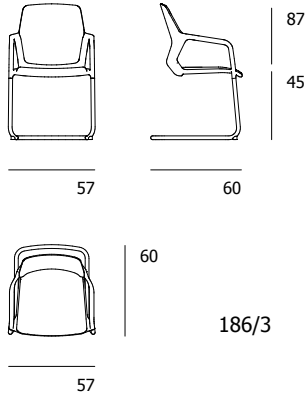
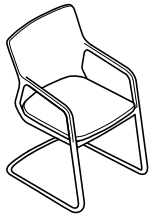

Metrik. 186 range. Technical details.

Wilkhahn

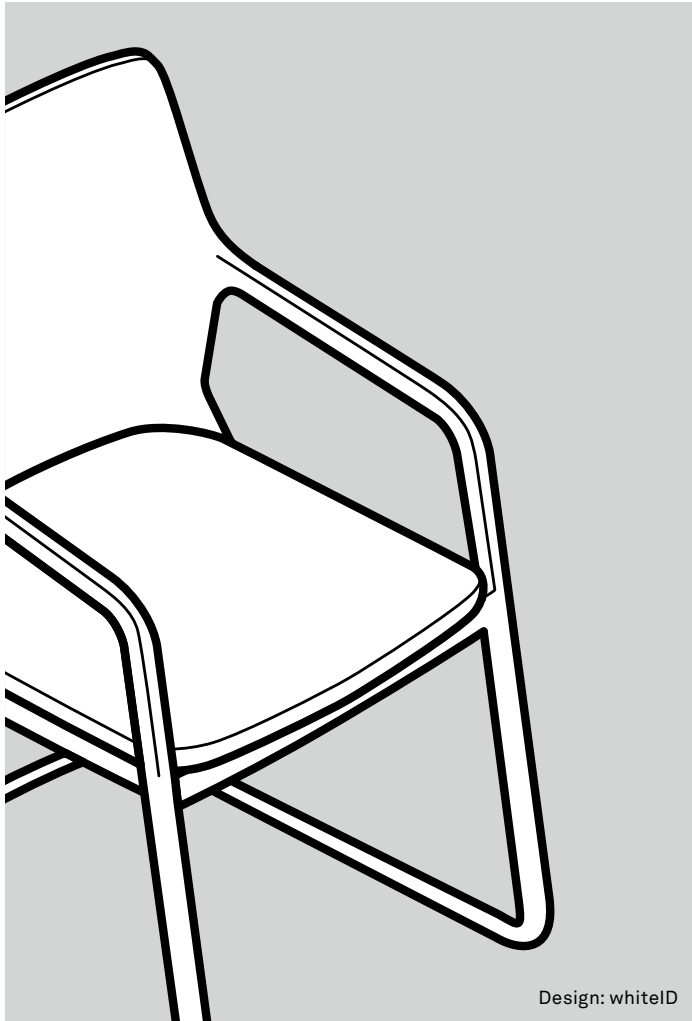

Design: whiteID

Function

The Metrik cantilever chair stands apart for its consistently integrated design approach. The way the components are integrated plays with contrasts such as distinctiveness and neutrality, comfort and an understated appeal, as well as modernity and timeless design. As a result, Metrik can be combined with a variety of table concepts and office chairs. Six colors for the body and frame, combined with a wide variety of covers and colors, offer highly scalable design options. To suit preferences, Metrik either complements the overall design concept or purposely adds a splash of color.

Chairs

Frame

Tubular steel frame optionally in a textured matte finish, coated in white, black, gray, gray-beige, bright chrome-plated or black chrome-plated, with black polyamide anti-tilt stopper as the standard version for carpets, optionally with multipurpose glides for hard flooring (e.g. stone), please order with extra felt glides for wooden flooring (e.g. parquet). Stacking buffer made of plastic to match the shells and colour of the frame.

Please note

Stacking versions with coated frames can cause colour to rub off, which is not covered by our guarantee. The same applies when inline connectors are used. We recommend chrome-plated versions for circumstances like these.

Seat and backrest

Unitary seat and backrest shell with integrated armrests made of through-dyed, fiberglass-reinforced polyamide the same as the base frame, optionally with a textured matte finish coated in white, black, gray or gray-beige. Replaceable seat cushioning, consisting of seat upholstery panel and covered polyurethane one piece molded foam. Type with optional, replaceable back cushioning the same as the seat cushioning. Weight 8.6 kg

Accessories

Inline connectors (2 in each set) made of black plastic.

Standards

The Metrik cantilever chairs comply with DIN EN 16139-L1 and ANSI/BIFMA X5.1 standards. In compliance with the DIN EN 16139-L1 office-chair standard, up to 4 chairs can be stacked vertically.



www.tuv.com
ID 1000000000

Information

When exposed to ultra violet rays for long periods of time, the colours of plastics can change slightly.

Metrik. Environment and product.



The Metrik cantilever chair – materials and parts reduced to the max

The objectives when developing Metrik were to create a multipurpose, durable and repair-friendly chair whose design was simple and required few materials.

Back in 1926, Dutch architect and designer, Mart Stam, who is considered the inventor of cantilever chairs, described it as like “sitting on air.” From the outset, the goal of the new chair development was an understated design that required few materials. Later on, high-performance tubular steel provided a sort of springy comfort, which is achieved solely through the cantilevered shape and not by adding extra components.

In the case of the Metrik cantilever chair, this exemplary ecological design principle has been evolved with the opportunities provided by contemporary plastic processing. The seat, backrest and armrests are made to form one single component. During the injection molding process, the material thickness required in terms of structural engineering, ergonomics and haptics, is achieved by injecting gas to minimize the weight and quantity of materials, despite the chair's size. As well as being very good value due to the reduction in component numbers, the process permits a seminal design so that Metrik will look contemporary for a long time to come.

Dowels are used to connect the through-dyed seat body in a form- and force-fit manner with the high-performance tubular steel to create a very robust and durable unit that's guaranteed to last and last. The through-dyed plastic ensures that scratches and signs of wear and tear are barely noticeable. The seat with its replaceable upholstery panel is screwed into the seat body. The optional backrest cushioning is also designed as a simple, replaceable upholstery panel. As a result, should the covers be permanently damaged or soiled, Metrik is easy to repair and can be used virtually indefinitely.

Metrik's superior durability, excellent comfort, generous size and stacking capability ensure that it can be used in different and varying settings, making it a very versatile and popular option.

At the end of its useful life, its two basic materials (steel and plastic) can simply be recycled.

Wilkhahn

Milestones of socio-ecological development at Wilkhahn

- 2019 and 2020 Presented with the Architects' Darling Award as a winner of the cradle-to-cradle challenge
- 2018 Wilkhahn receives the B.A.U.M. environmental prize and an award from the Lower Saxony Alliance for Sustainability.
- 2013 The company is connected to the district heating grid of a biogas plant nearby
- 2012 The ON office chair is presented with the Federal Ecodesign Award
- 2009 Wilkhahn signs a framework agreement with German trade union BHI (Building and Woodworkers International) on worldwide compliance with core ILO labor standards at Wilkhahn and its suppliers via in-house controls and external monitoring by German trade union IG Metall.
- 2008 A combined heat and power plant based on renewables is commissioned.
- 2001 First company in the state of Lower Saxony with EMAS 2 European environmental standard certification.
- 2000 Publishes one of the first medium-sized business reports on sustainability
- 1997 Corporate Conscience Award from the Council on Economic Priorities, New York
- 1996 German Environmental Prize from the German Environmental Foundation
- 1992 The first ecologically designed production facilities with a photovoltaic roof and launch of the first office chair range to be developed based on the ecological design concept.
- 1989 Mission statement on ecological changes at Wilkhahn: "The administrative and management board have jointly decided to take ecological concerns seriously and to place greater emphasis on them than a quick profit".

Awards



Metrik. Product responsibility.

Wilkhahn

Our antidote to the throw-away society is to provide products where form, function and materials have a purpose and are long lasting. Our product responsibility concept therefore follows well-defined guiding principles.



1. Avoid waste – “the longer and better”

is the remit to our product development team. We achieve this thanks to:

- useful innovations that make life easier and more pleasant in the long term;
- durable quality of materials, surfaces and technical solutions, which guarantees quality, even years later;
- distinctive, timeless and appealing designs with the potential to become classics;



2. Reduce – “less is more”

is more than just a design principle to us, it means:

- we cut down on the materials used in order to make handling easier and to preserve resources;
- we use energy in manufacturing efficiently, for example by drawing on district heating and heat recovery in manufacturing;
- we reduce emissions, by utilizing solar power and climate-neutral energy sources (cutting CO₂).



3. Recover – “Reuse + Recycle”

In this case, the goal is to continue to use the whole product or parts of it and recycle it at the end:

- Because the products are modular, expendable parts can be exchanged and features added or retrofitted (e. g. armrest types, covers, cushions, surfaces).
- Connecting points in the product can be dismantled for easy repair.
- Where possible, we use pure materials that are marked as such, making them ideal for recycling.



4. Fairness – responsibility all along the line

At Wilkhahn, environmental and social responsibility have an equal weighting. Health and safety, training, active participation by and fair pay for employees are integral to our corporate culture. As a result, we actively encourage our suppliers and customers worldwide to improve working conditions. Which is why Wilkhahn joined Global Compact and signed an international framework agreement with the International Labor Organization (ILO) on global recognition and fostering of employee interests.

Metrik. Environmental product information.

Guiding principles.

Honest product design

We strive to develop durable products, increase their utility value and reduce waste. "Less is more" or "reduce to the max" are principles that Wilkhahn constantly reinterprets for the future. Ecological design guidelines are integral components of Wilkhahn product development.

A spirit of fairness

We focus on people. This implies a collaborative management style which sees employee representatives as co-managers who help shape the company. The workforce's participation in the company's success, the development of new styles of working with semi-autonomous groups and project work, as well as an established health-management system are expressions of Wilkhahn's social approach.

Ecological responsibility

Wilkhahn supports sustainable development. The balance we seek to strike between financial, ecological, social and cultural objectives in order to maintain independence defines Wilkhahn's corporate culture. Compliance with ecological quality criteria throughout the product life cycle is one of the ways we gauge our own success.

Responsibility from the very start – Wilkhahn's environmental product information.

The environmental impact of all Wilkhahn products throughout their whole product lives, which includes production of the feedstock, manufacture, use and disposal of the products, was assessed based on a life-cycle analysis (LCA).



Materials

Socio-ecological assessment of the production of the feedstock, the procurement process, the materials used and their characteristics.



Production

Socio-ecological assessment of the production and assembly processes by environmental-management and social-audit systems.



Product use

Socio-ecological assessment of the product utility phase regarding: Design, ergonomics, durability, customer service, availability of spare parts.



End of the product life-cycle

Socio-ecological assessment of the product after the end of its useful life: Disassembly and recycling capabilities, disposal and product take-back.

Wilkhahn

Metrik. Environmental product information.

Wilkhahn



Materials.

International product and material standards.

During all phases of a product's development, we're demanding when it comes to the characteristics of our products, the quality of the materials and components, as well as the standard of our craftsmanship. Therefore, Wilkhahn products fulfil all relevant international office-furniture standards in terms of durability, safety and ergonomics. And what's more, many Wilkhahn products have also been awarded the GS symbol which rates them as being safe and as suitable for interiors as specified by Greenguard™. The materials Wilkhahn uses such as fabrics, leather, wood, plastics or metals are primarily made by highly specialized suppliers. Our product-development department specifies the technical and aesthetic characteristics that these materials have to fulfil. Our specifications on for example strength, color-fastness, durability and other characteristics that affect the quality of our products are clearly outlined by international material standards. Rules of thumb are as follows:

- The fabrics and leather used by Wilkhahn are low on emissions and help to provide good air quality in buildings and working environments;
- Wherever possible, Wilkhahn works with ecological upholstery fabrics, such as wool fleeces, cork and coconut fiber;
- All Wilkhahn polyurethane foam is free of CFCs and has no halogenated flame retardants. This helps protect the climate and is important for recycling capabilities at a later date. Nevertheless, Wilkhahn products can also fulfil special requirements as regards fire safety in public buildings, for example by applying flame-retardant upholstery fabrics. Additional flame-retardant materials are only added if required by our customers' stringent fire safety regulations.
- The powder-coated metal finishes of the table and chair frames are hard-wearing and made without any solvents or heavy metal.
- Chrome-plated metal finishes have no harmful chrome compounds (as specified in EN 71-3).

Wilkhahn attaches huge importance to the fact that its products and the associated materials, procedures and processes are responsible in social and ecological terms. Therefore, integrated audits help us check that our partners in the Wilkhahn supply chain comply with these aspects too. We check the quality of our products by inspecting incoming goods according to established criteria. Before processing, our materials are scrutinized and the finished results checked again by trained staff before forwarding to the next department.

Metrik. Environmental product information.

Wilkhahn



Production.

Integrated management system

Wilkhahn headquarters in Bad Münde (Germany) are EMAS-validated and certified to ISO 14001. Wilkhahn supports relevant certification on the part of its suppliers. Wilkhahn's main production site is certified to ISO 9001. In selecting suppliers, comprehensive and proper quality management are very important to Wilkhahn.

Water conservation, material management and sustainable energy production

Water is becoming an increasingly important resource. Wilkhahn is pulling out all the stops to minimize water consumption during production and to ensure water quality is not impaired.

By treating and recycling process water, the quantities of waste water considered hazardous have been cut by 80 percent. The Wilkhahn waste management concept includes sorting waste selectively, as well as recycling and disposing of all waste fractions resulting from the production and management departments.

All Wilkhahn production facilities ensure compliance with labor and social responsibility standards, as required by the ILO (International Labor Organization). Our partnership with suppliers is based on compliance with this agreement.

Sustainability in the supply chain.

Our environmental and social responsibility doesn't stop at the gates to our own factories.

If within its power, Wilkhahn requires and promotes fair and safe working conditions and processes that don't harm the environment. Frequent assessment and on-site visits to top suppliers create trust and sustainability in the supply chain too.

Employees as partners.

Our maxim is fairness and aspects like trust and reliability define Wilkhahn's management culture and the way it involves its own workforce. Active participation by all employees is a driving force in encouraging continual and successful improvements in the environmental sector too. Whether it's a question of avoiding hazards in the workplace, of new manufacturing technologies, or of saving materials and energy – all employees can contribute their ideas for improving Wilkhahn at any time via the company's ideas management process.

Health and safety

Wilkhahn applies a wide range of measures to ensure that workspaces in the Wilkhahn production department are safe and allow as risk-free an approach as possible. This is achieved by:

- Planning safe procedures and workspaces;
- Organizing and defining responsibilities;
- Informing people about the risks the workspace entails and taking measures to avoid these;
- Regularly inspecting working environments to maintain safety and cleanliness in all areas;
- Using the health and safety committee to frequently discuss risk potentials and systematically avoid accidents.

Metrik. Environmental product information.

Wilkhahn



Usage.

Aesthetics and design

Sustainable products must be practical. The timeless aesthetics of Wilkhahn products provide added value, making them options that are set to endure. Office work today requires maximum flexibility in terms of spaces, usage concepts, processes and people. New studies show that aesthetics have a direct impact on health.

Durability and guarantee

Product design to last is our antidote to the throw-away society. Therefore, Wilkhahn products focus on providing maximum utility value, durability and protecting resources. This means top quality that can be experienced, is consistent and perfect. It delivers timeless, distinctive design that is fascinating due to its simplicity, honesty and appeal to all the senses. Pioneering innovations are included that really give our customers constant added value in terms of ergonomics and handling. The fact that our products are extremely practical, easy to disassemble and components are replaceable ensures they are resource-efficient.

Air quality and emissions of harmful substances

Wilkhahn products don't emit any concentrations of gas that are harmful to the environment or health. In the US, Wilkhahn products have GREENGUARD Indoor Air Quality™ certification. GREENGUARD™ is a certification program for products low in emissions.

LEED

Wilkhahn office chairs and table ranges help companies to achieve credit points during LEED certification (U.S. Green Building Council's Leadership in Energy and Environmental Design). The LEED Green Building Rating System is a voluntary standard given to companies that offer a healthy environment, save water and energy and comply with stringent environmental criteria. More LEED information about our products is available on request.

Metrik. Environmental product information.

Wilkhahn



End of the product life cycle.

Product take-back and recycling

Even after the product has reached the end of its life, we still feel responsible and offer our customers extensive take-back and recycling services. We guarantee to take back all products that are no longer in use. Wilkhahn products are dismantled in the factory, all parts are selectively sorted in terms of their inherent materials and then recycled. By labelling the materials, ensuring they're non-toxic and easy to dismantle, we're already making sure today that the components in Wilkhahn products can be incorporated into local material and production cycles and be properly recycled and disposed of. As a result, energy-guzzling (and therefore ecologically unwise transportation) over long distances is avoided.

Disassembly and recycling

All Wilkhahn product components are suitable for non-destructive disassembly. In order to guarantee materials are sorted according to type, all components over 150 g in weight are labeled. No agents to protect materials, or organic halogen compounds are used that prevent recycling at a later date.

Reusable packaging for transport

Customers in over 90 countries choose Wilkhahn office furniture. For years we've only been using as much packaging to transport our products as is required to deliver them in one piece to our customers. Some 60 to 78% of Wilkhahn's cardboard packaging consists of recycled material. And Wilkhahn regularly uses blankets and other returnable packaging.

Metrik. Environmental product information.

Wilkhahn

Materials.

Material composition for the Metrik 186/3 model

	[kg]	[%]
Metals	3.20	31.0
Steel	3.20	31.0
Aluminum	0.00	0.0
Plastics	6.20	62.0
Polypropylene (PP)	1.30	13.0
Polyamide (PA)	4.30	42.0
Polyurethane (PUR)	0.70	6.0
Others	0.70	7.0
Upholstery material (e.g. wool)	0.70	7.0
Total weight	10.10	100.0
Percentage recycled	1.60	16.0
Recycling capability	9.40	93.0

Not recyclable: Upholstery material, Teflon glides

Materials are subject to stringent checks. As part of an ABC analysis, the materials are checked to ensure they are environmentally friendly and not harmful to health. Prohibited chemicals are not used in the product at all. All feedstock is listed in a register of hazardous substances. This helps to minimize the use or substitution of any potentially harmful materials.

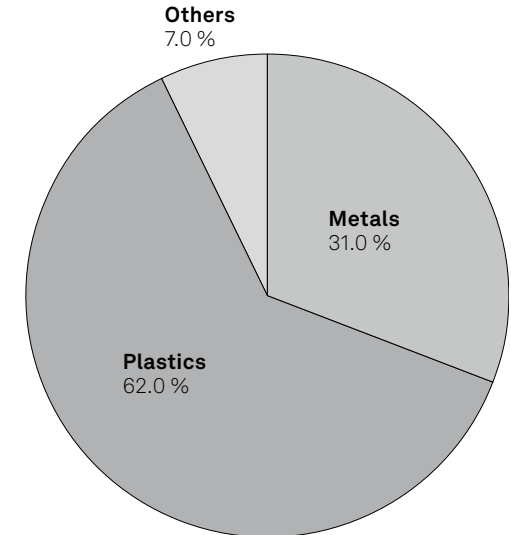

Metrik. 186 range. Awards / standards / certificates.

Wilkhahn

Awards



Product certificates / product standards



DIN EN 16139-L1 ANSI / BIFMA X 5.1

Company's certificates, memberships



Wilkhahn and sustainability

Wilkhahn



In over 100 years of its corporate history, Wilkhahn can look back on a sustainability philosophy that has grown over decades. Aspects such as durability, social fairness, environmental responsibility and cultural orientation have been evolving as corporate principles since the 1950s. Wilkhahn today is regarded internationally as a model of excellence, not only on account of its products but also because of its modern corporate philosophy. This is because the company realized early on that sustainable design should embrace environmental aspects, improve social relationships and define the cultural role of a company. This approach to the way we do business creates a bond between us and our customers throughout the world. There is surely no more rewarding task than working together for a successful future that is worth living in.

📄 [Current sustainability report with environmental statement](#)



For further information please contact us!

Wilkhahn



Wilkening + Hahne GmbH+Co.KG
Fritz-Hahne-Str. 8
31848 Bad Münder
Germany
Tel.: +49 5042 999 100
contact@wilkhahn.de
www.wilkhahn.com



Roof of one of the four pavilions,
which were designed by architect
Frei Otto, on the Wilkhahn site.
Photo: Klemens Ortmeier