

Wilkhahn

Contas. 540 range.





Contas.

The success of training and skills development depends greatly on the facilities that support these processes. Flexible class sizes and methods require tables that can adjust to whatever the room's current demands are. Furthermore, the quality of the furnishings has an impact on the importance attached to personnel and corporate development.

Contas is an intelligent, superior and durable furnishing solution that quickly pays dividends. The clarity and quality of this sophisticated table system's design is impressive. It cuts an equally fine figure in conference rooms and highlights the importance of the occasion. Contas also offers attractive cost benefits in terms of facility management. Contas can adapt to different numbers of participants, course methods and room shapes. Tool-free assembly turns the table systems into single tables, linked rows or grouped into horse-shoe shapes or blocks in no time. The patented interlocking mechanism and the clever integration of all functions save time and money. The frame is bright chromium plated, with a choice of laminate and veneer tabletops.



Contas. 540 range. Technical details.

Wilkhahn

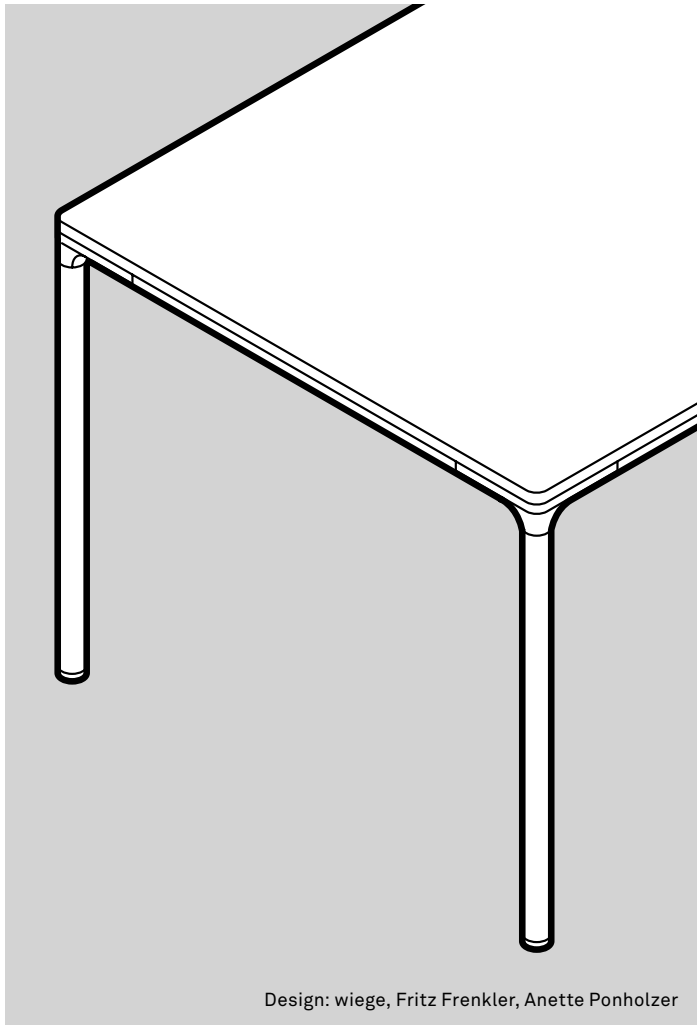

Design: wiege, Fritz Frenkler, Anette Ponholzer

Function

Lightweight and flexible conference table system for multipurpose conference, seminar and training spaces. It consists of standalone tables which are optionally foldable and stackable, and connecting leaves allowing quick, easy and tool-free linkage and configuration of the tables using a patented swivel-mounted connector plate.

Frame

Bright chrome-plated or coated Ø 38 mm tubular steel legs. Glides (for folding tables with disc profiles) made of black polyamide for soft flooring (standard) and black polyurethane for hard flooring (please state when ordering). Optionally as a stackable version (with integrated separator) and retractable table legs that are locked in place by a leg retaining clamp in the table top. Black polyamide retaining clamp. Connector plate for tables and connecting leaves made of bright chrome-plated or coated die-cast zinc. Connecting leaves' connector plate with separator and retention mechanism. Tables fitted with table-table-connectors.

Core material of table top

Lamin board with straight, concealed lipping.

Table top group 1 - laminate

Thickness 34 mm
Laminate based on the Wilkhahn colour and surface finish samples with beech lipping, natural oiled finish.

Table top group 2 – veneer

Table top thickness 34 mm
Variant 1: Beech, oak or ash veneer from Wilkhahn woodstain colour samples with lipping, colour matched as far as possible with the veneer. Variant 2: Maple, walnut or elm veneer based on the Wilkhahn woodstain colour samples with wood lipping colour matched as far as possible with the veneer.

Veneer type

As a standard, the veneer panels are slip-matched. Surfaces sealed with clear lacquer: oak, ash, walnut and elm veneer closed-pore: maple and beech veneer. Some specific growth features possible.

Modesty panels

Aluminium frame, coated with a silver satin finish, covered with transparent fabric in anthracite. Black polyamide handles.

Standards

The Contas tables comply with the DIN EN 527 standard.

When placing repeat orders, please indicate whether your table tops have slip-matched or book-matched veneer.

Contas. 540 range. Product types.

Wilkhahn

Table top groups

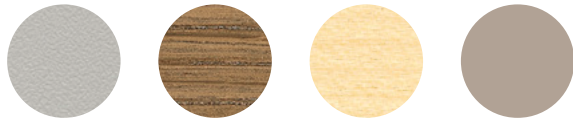

Laminate, veneer type 1 or 2, soft matt laminate, you can find further surfaces in our media center

Laminate. The material is made by bonding cellulose and décor paper layers, as well as resin, by applying heat and pressure. This produces an extremely tough surface that comes in a variety of different colours. Laminate is highly recommended for areas where the tables are subject to a lot of wear and tear because they are frequently moved around for example.

Wood veneers. Natural wood is a living material: in the way it looks and changes over the years. Sometimes more significantly and sometimes more subtly, depending on the type of wood and how light it is. If a more consistent look is preferred, stained surfaces or industrially produced veneer are available.

You can find our current fabric collection in our media center

Frame versions

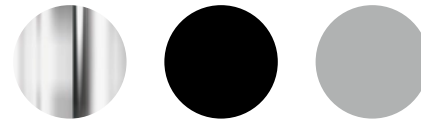

Tubular steel bright chrome plated, black or silver-coated matt satin finish

The digital sample colours differ from the originals.

Contas. 540 range. Accessories and other items.

Wilkhahn



The stackable folding-leg tables are fascinating and practical. Place the table with the top face down, turn legs to release, pull up, fold up and snap into the integral retaining clamp. This automatically exposes the separators, which provide a soft, non-slip buffer for stacking purposes.



246/75 Four-wheeled trolley to take five folding tables 540/15 (table depth 75 cm)

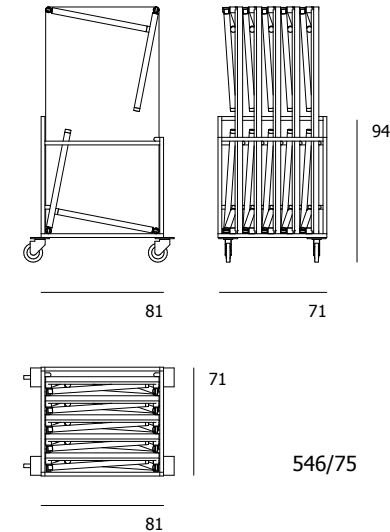
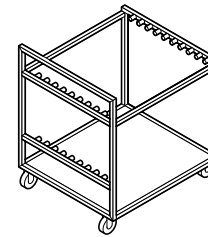

546/90 Four-wheeled trolley to take five folding tables 540/25 (table depth 90 cm)

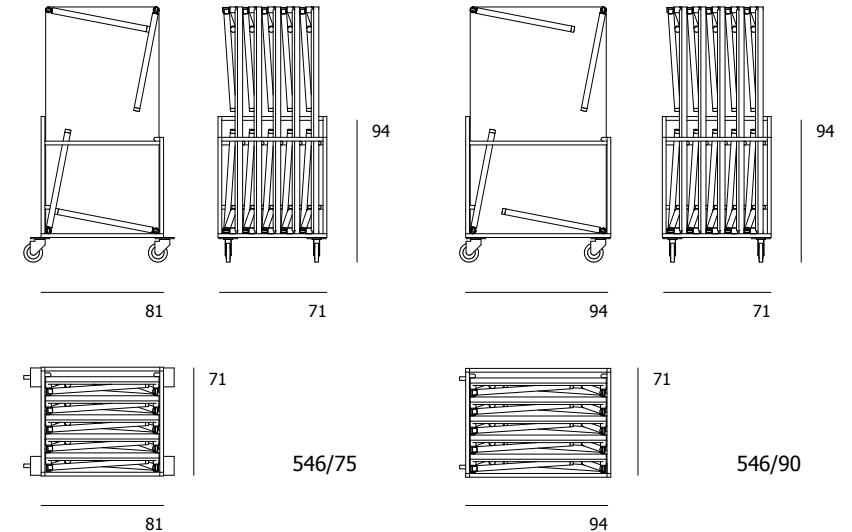
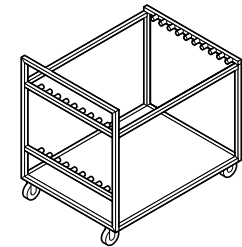

Contas. 540 range. Accessories and other items.

Wilkhahn

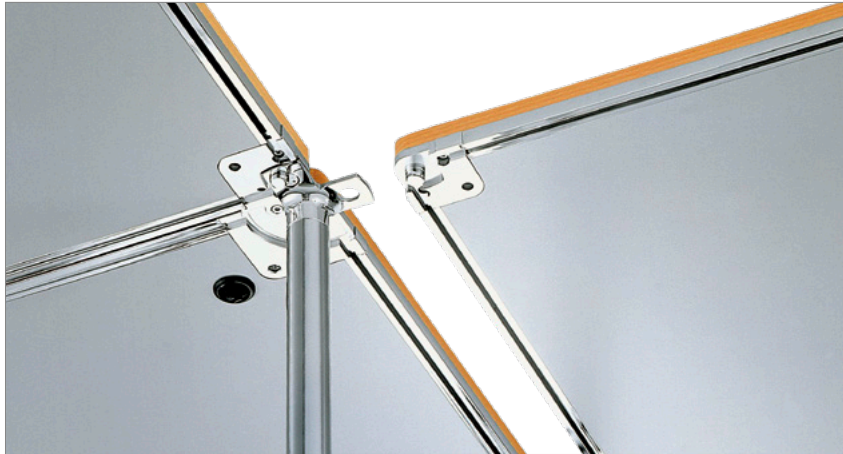

The patented multiple corner connector lies at the core of Contas. It has a simple, swing-out mechanism to take one or two connecting leaves. As a result, quick, tool-free assembly, dismantling and adaption of complex table systems is possible.

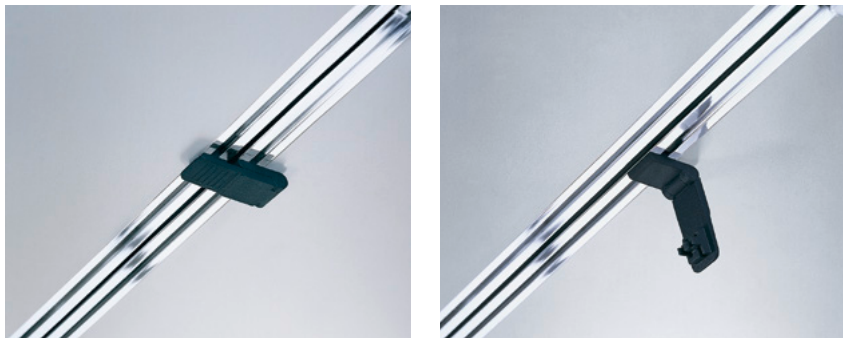

Interlocking connectors, slotted into the frame profiles, permit direct linking of single tables, for example in a block configuration, and firm attachment of a 90° connecting leaf at both ends.

541/15 Connecting leaf, panel depth 75 cm

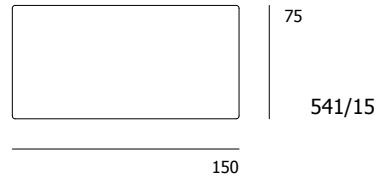
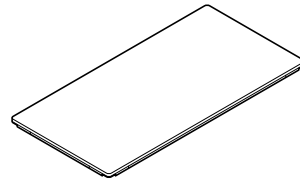

541/25 Connecting leaf, panel depth 90 cm

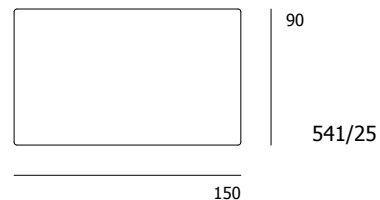
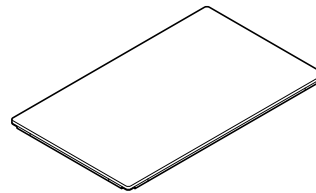

549/02 Modesty panel

Length 65, H 40, for models 540/11 and short edges of models 540/15 and 540/18

549/03 Modesty panel

Length 80, H 40, for the front edges of the 540/25 and 540/28 models

549/04 Modesty panel

Length 140, H 40, for models 540/15 and 540/25

549/05 Modesty panel

Length 170, H 40, for models 540/18 and 540/28

549/10 Modesty panel

Length 148, H 40, for models 541/15 and 541/25

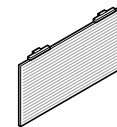

549/20 Table-table connector



549/21 Table-connecting leaf connector



Contas. 540 range. Models and dimensions.

Wilkhahn

540/11

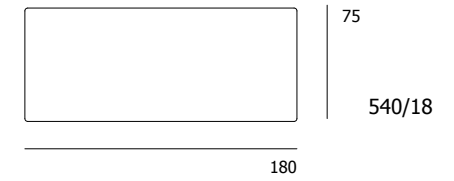
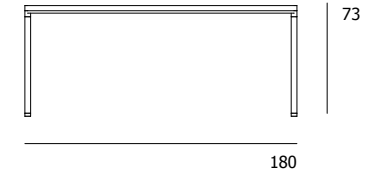
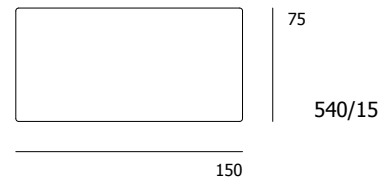
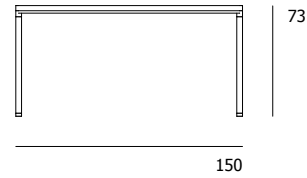
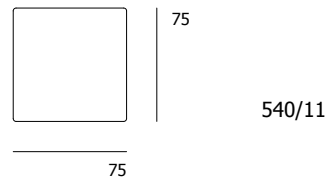
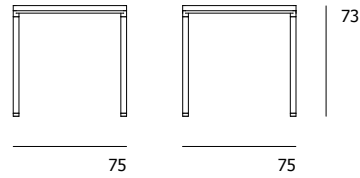
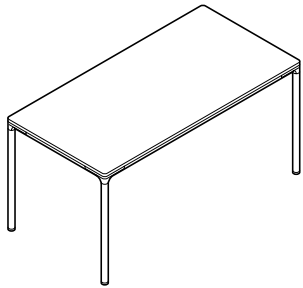

540/15

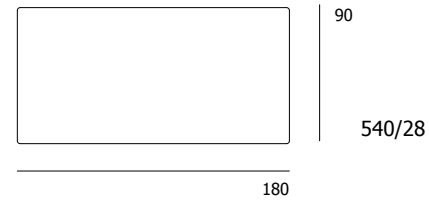
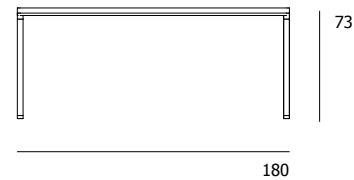
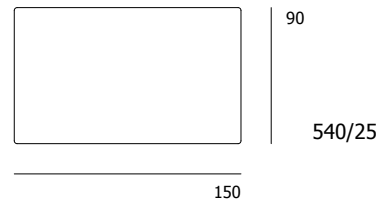
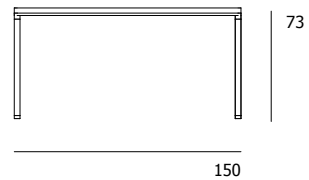
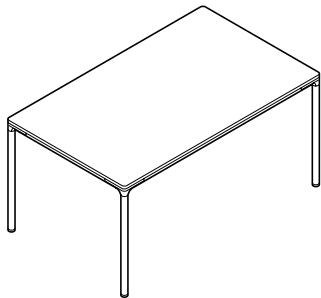

Contas. 540 range. Awards/standards/certificates.

Wilkhahn

Awards



Product certificates/product standards



DIN EN 527

Company's certificates, memberships

